

Forged Fittings

The best partner for value creation
We support the innovations of customers



11



Catalogue No. S-LOK Oct.2020

90° Elbow

SWLA



250

45° Elbow

SWLB



250

Tee

SWTA



251

Cross

SWXA



251

Full Coupling

SWFC



252

Half Coupling

SWHC



252

Cap

SWCA



253

Boss

SWBA



253

Union

SWUA



254

Union

SWUAO



254

Male Connector

SWMC-R

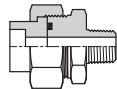

255

Male Connector

SWMC-G

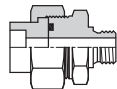

255

Reducing Insert

SWRM



256

Reducing Coupling

SWRC



257

Boss Type R

SWBR



257

90° Elbow

SLA



258

45° Elbow

SLB



258

Tee

STA



259

Cross

SXA



259

Full Coupling

SFC



260

Half Coupling

SHC



260

Cap

SCA



260

Hex Head Pulg

SPB



261

Square Pulg

SPD



261

Round Plug

SPE



261

Reducing Coupling

SRC



261

Hex Nipple

SNA



262

Reducing Nipple

SNR



262



Hex Socket
SSA 262



Hex Bushing
SHB 263



Boss
SBA 263



Boss
SBR 263



Union
SUA 264



Union
SUAO 264



Weldolet
SWLT 265

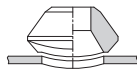

Sockolet
SCLT 266

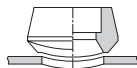

Threadolet
STLT 266

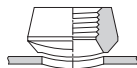

Nippolet 267

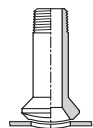

Swage Nipple 267

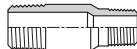

SOCKET WELDING & THREADED FITTINGS

Pressure Ratings

These fittings shall be designated as pressure class 2000, 3000 And 6000 fittings for threading and pressure class 3000,6000 and 9000 for socket-welding. This designation identifies the fittings with their ratings as shown as follow, Table 1.

Table 1:Correlation of Fittings Class With Schedule Number of Wall Designation of Pipe for Calculation of Ratings.

Pressure Class Designation of Fitting	Type of Fitting	Pipe Used for Rating Basic	
		Schedule No.	Wall Designation
2000 lb	Threaded	80	X-S
3000 lb	Threaded	160	-
6000 lb	Threaded	-	XX-S
3000 lb	Socket-Welding	80	X-S
6000 lb	Socket-Welding	160	-
9000 lb	Socket-Welding	-	XX-S

- This table is not intended to restrict the use of pipe of thinner or thicker wall with fittings.
- Pipe actually used may be thinner or thicker in nominal wall than that shown in Table 1.
- When thinner pipe is used its strength may govern the rating.
- When thicker pipe is used (e.g., for mechanical strength) the strength of the fitting governs the rating.

Table 2 : Nominal wall thickness of Schedule 160 and Double Extra Strong Pipe.

NPS.	Schedule 160		XX-S	
	in	mm	in	mm
1/8	0.124	3.15	0.190	4.83
1/4	0.145	3.68	0.230	6.05
3/8	0.158	4.01	0.252	6.40

Table 3 : Pressure/ Temperature Ratings Non-shock Working Pressure in Pounds per Square Inch

Service Temperature Degree°F	2000lb Threaded Fittings					3000lb Socket Welding and Threaded Fittings					6000lb Socket Welding and Threaded Fittings				
	Carbon steel	F304	F316	F22	F5	Carbon steel	F304	F316	F22	F5	Carbon steel	F304	F316	F22	F5
100	2000	1715	2000	2000	2000	3000	2570	3000	3000	3000	6000	5145	6000	6000	6000
150	1970	1615	1970	1970	1970	2950	2425	2950	2950	2950	5915	4855	5915	5915	5915
200	1940	1520	1940	1940	1940	2915	2280	2915	2915	2915	5830	4565	5830	5830	5830
250	1915	1445	1915	1915	1915	2875	2170	2975	2975	2975	5750	4340	5750	5750	5750
300	1975	1370	1896	1895	1895	2845	2055	2845	2845	2845	5690	4115	5690	5690	5690
350	1875	1310	1875	1875	1875	2810	1965	2810	2810	2810	5625	3930	5690	5625	5625
400	1850	1245	1850	1850	1850	2775	1870	2775	2775	2775	5550	3745	5550	5550	5550
450	1810	1195	1810	1710	1810	2715	1790	2715	2715	2715	5430	3585	5430	5430	5430
500	1735	1140	1735	1635	1735	2605	1715	2605	2605	2605	5210	3430	5210	5210	5210
550	1640	1100	1640	1540	1640	2460	1650	2460	2460	2460	4925	3305	4925	4925	4925
600	1540	1060	1540	1440	1540	2310	1590	2310	2310	2310	4620	3180	4620	4620	4620
650	1430	1020	1430	1330	1430	2150	1535	2150	2150	2150	4300	3070	4300	4300	4300
700	1305	985	1370	1240	1340	1960	1480	2055	2010	2010	3920	2960	4110	4025	4025
750	1180	950	1305	1145	1245	1775	1425	1960	1870	1870	3550	2850	3920	3745	3745
800	1015	915	1240	1055	1155	1525	1370	1865	1735	1735	3050	2745	3730	3470	3470
850	830	880	1180	1060	1060	1250	1330	1770	1595	1595	2500	2660	3540	3190	3190
900	615	860	1115	970	970	925	1290	1675	1455	1455	1885	2580	3350	2915	2915
950	425	845	1055	880	880	640	1270	1580	1320	1320	1295	2540	3165	2640	2640
1000	235	830	990	740	695	350	1250	1485	1115	1240	715	2500	2975	2230	2085

Size Identification

The size of a fitting is identified by the nominal pipe size.

For reducing fittings, the size of the largest run opening is to be given first, followed by the size of the opening opposite of the same run.

The branch size of a Tee is given last.

Where the case is a Cross, the largest side-outlet is thirdly given, then the opening opposite.

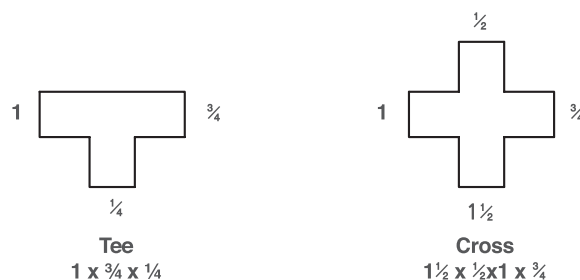

Threads

- Unless otherwise specified in inquiry, all threaded fittings are supplied with NPT threads (ANSI B2.1 American Standard Taper Pipe Thread) for reference, other available threads are:
- ISO/R7, Pipe Threads for Gas List Tubes and Screwed Fittings where Pressure-tight Joints are made on the threads (BS 2.1 & JIS B0203PT Thread).
- API 5B, Line Pipe Threads.
- KSB0222 Taper Pipe Threads

90° Elbow
SWLA

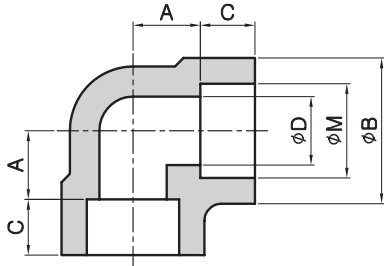

Part No.	Size	M	B	D	A	C	Unit Weight (kg)
3000 lb							
SWLA80-02	¼	See Note (1) To be specified by purchaser	23	9.4	11.1	10	0.132
SWLA80-03	⅜		26.5	12.7	13.4	10	0.113
SWLA80-04	½		34.0	16.1	16.0	13	0.226
SWLA80-06	¾		38.5	21.2	20.0	16	0.312
SWLA80-08	1		46.5	27.0	23.0	16	0.596
SWLA80-10	1¼		56.5	35.4	28.0	18	0.709
SWLA80-12	1½		63.5	41.2	33.0	20	0.850
SWLA80-16	2		76.0	52.7	40.0	22	1.474
SWLA80-20	2½		92.0	62.7	42.0	24	2.460
SWLA80-24	3		110.0	78.0	57.1	31.5	4.650
SWLA80-32	4	146.0	102.0	70.0	45	9.410	
6000 lb							
SWLA160-04	½	See Note (1) To be specified by purchaser	38.5	12.0	20.0	16	0.425
SWLA160-06	¾		46.5	15.8	23.0	16	0.652
SWLA160-08	1		56.5	21.0	28.0	18	1.020
SWLA160-10	1¼		63.5	29.7	33.0	20	1.446
SWLA160-12	1½		76.0	34.2	40.0	22	2.380
SWLA160-16	2		92.0	43.1	42.0	24	3.760
SWLA160-20	2½		110.0	54.0	57.1	24	6.120
SWLA160-24	3		121.0	67.7	66.0	31.5	8.760
SWLA160-32	4		152.0	87.0	70.0	45	14.300
9000 lb							
SWLAXXS-04	½	See Note (1) To be specified by purchaser	46.5	6.4	23.0	16	0.510
SWLAXXS-06	¾		56.5	11.0	28.0	16	0.782
SWLAXXS-08	1		63.5	15.2	33.0	18	1.224
SWLAXXS-10	1¼		76.0	22.7	40.0	20	1.807
SWLAXXS-12	1½		92.0	27.9	42.0	22	2.975
SWLAXXS-16	2		110.0	38.1	54.0	24	4.700
SWLAXXS-20	2½		121.0	45.0	66.0	24	10.512
SWLAXXS-24	3		146.0	58.4	70.0	31.5	13.020

45° Elbow
SWLB

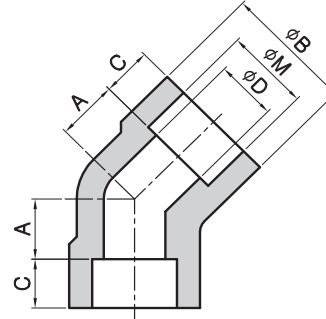

Part No.	Size	M	B	D	A	C	Unit Weight (kg)
3000 lb							
SWLB80-02	¼	See Note (1) To be specified by purchaser	23	9.4	7.9	10	0.093
SWLB80-03	⅜		26.5	12.7	7.9	10	0.142
SWLB80-04	½		34.0	16.1	13.0	13	0.264
SWLB80-06	¾		38.5	21.2	13.0	14	0.397
SWLB80-08	1		46.5	27.0	14.0	16	0.624
SWLB80-10	1¼		56.5	35.4	18.0	18	0.907
SWLB80-12	1½		63.5	41.2	22.0	20	0.782
SWLB80-16	2		76.0	52.7	24.0	22	1.265
SWLB80-20	2½		92.0	62.7	29.0	24	3.062
SWLB80-24	3		110.0	78.0	34.0	31.5	4.763
SWLB80-32	4	146.0	102.0	42.0	45	8.250	
6000 lb							
SWLB160-04	½	See Note (1) To be specified by purchaser	38.5	12.0	13	16	0.397
SWLB160-06	¾		46.5	15.8	14	16	0.595
SWLB160-08	1		56.5	21.0	22	18	0.935
SWLB160-10	1¼		63.5	29.7	22	20	1.157
SWLB160-12	1½		76.0	34.2	24	22	1.982
SWLB160-16	2		92.0	43.1	29	24	4.000
SWLB160-20	2½		110.0	54.0	34	24	5.875
SWLB160-24	3		121.0	67.7	34	31.5	6.509
SWLB160-32	4		152.0	87.0	42	45	12.360
9000 lb							
SWLBXXS-04	½	See Note (1) To be specified by purchaser	46.5	6.4	14	16	0.875
SWLBXXS-06	¾		56.5	11.0	22	16	1.369
SWLBXXS-08	1		63.5	15.2	22	18	1.725
SWLBXXS-10	1¼		76.0	22.7	24	20	2.931
SWLBXXS-12	1½		92.0	27.9	29	22	5.062
SWLBXXS-16	2		110.0	38.1	34	24	6.400
SWLBXXS-20	2½		121.0	45.0	34	24	7.925
SWLBXXS-24	3		146.0	58.4	42	31.5	11.569

(1) For the 'Bore(M)' other than standard pipe outside diameter.
-Dimensions are in millimeters.
-Dimensional Tolerances See ANSI B16.11 or JIS B2316

Tee
SWTA

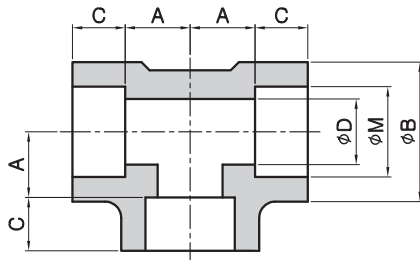

Part No.	Size	M	B	D	A	C	Unit Weight (kg)
3000 lb							
SWTA80-02	¼	See Note (1) To be specified by purchaser	23	9.4	11.1	10	0.161
SWTA80-03	⅜		26.5	12.7	13.4	10	0.142
SWTA80-04	½		34.0	16.1	16.0	13	0.170
SWTA80-06	¾		38.5	21.2	20.0	16	0.397
SWTA80-08	1		46.5	27.0	23.0	16	0.624
SWTA80-10	1¼		56.5	35.4	28.0	18	0.907
SWTA80-12	1½		63.5	41.2	33.0	20	1.134
SWTA80-16	2		76.0	52.7	40.0	22	1.701
SWTA80-20	2½		92.0	62.7	42.0	24	3.424
SWTA80-24	3		110.0	78.0	57.1	31.5	5.670
SWTA80-32	4	146.0	102.0	70.0	45	12.247	
6000 lb							
SWTA160-04	½	See Note (1)	38.5	12.0	20.0	16	0.623
SWTA160-06	¾		46.5	15.8	23.0	16	0.907
SWTA160-08	1		56.5	21.0	28.0	18	1.503
SWTA160-10	1¼		63.5	29.7	33.0	20	1.701
SWTA160-12	1½		76.0	34.2	40.0	22	2.948
SWTA160-16	2		92.0	43.1	42.0	24	3.702
SWTA160-20	2½		110.0	54.0	57.1	24	8.723
SWTA160-24	3		121.0	67.7	66.0	31.5	10.660
SWTA160-32	4		152.0	87.0	70.0	45	19.020
9000 lb							
SWTAXXS-04	½	See Note (1)	46.5	6.4	23.0	16	0.779
SWTAXXS-06	¾		56.5	11.0	28.0	16	1.333
SWTAXXS-08	1		63.5	15.2	33.0	18	1.879
SWTAXXS-10	1¼		76.0	22.7	40.0	20	2.126
SWTAXXS-12	1½		92.0	27.9	42.0	22	3.685
SWTAXXS-16	2		110.0	38.1	54.0	24	4.627
SWTAXXS-20	2½		121.0	45.0	66.0	24	10.903
SWTAXXS-24	3		146.0	58.4	70.0	31.5	13.325

Cross
SWXA

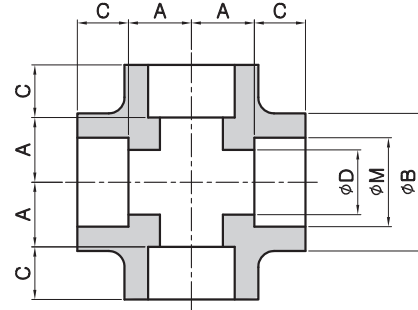

Part No.	Size	M	B	D	A	C	Unit Weight (kg)
3000 lb							
SWXA80-02	¼	See Note (1) To be specified by purchaser	23	9.4	9.4	10	0.182
SWXA80-03	⅜		26.5	12.7	12.7	10	0.170
SWXA80-04	½		34.0	16.1	16.1	13	0.368
SWXA80-06	¾		38.5	21.2	21.2	16	0.519
SWXA80-08	1		46.5	27.0	27.0	16	0.680
SWXA80-10	1¼		56.5	35.4	35.4	18	1.020
SWXA80-12	1½		63.5	41.2	41.2	20	1.389
SWXA80-16	2		76.0	52.7	52.7	22	2.326
SWXA80-20	2½		92.0	62.7	62.7	24	7.484
SWXA80-24	3		110.0	78.0	78.0	31.5	10.432
SWXA80-32	4	146.0	102.0	102.0	45	18.144	
6000 lb							
SWXA160-04	½	See Note (1)	38.5	12.0	20.0	16	0.660
SWXA160-06	¾		46.5	15.8	23.0	16	1.120
SWXA160-08	1		56.5	21.0	28.0	18	1.730
SWXA160-10	1¼		63.5	29.7	33.0	20	2.381
SWXA160-12	1½		76.0	34.2	40.0	22	3.750
SWXA160-16	2		92.0	43.1	42.0	24	7.860
SWXA160-20	2½		110.0	54.0	57.1	24	10.600
SWXA160-24	3		121.0	67.7	66.0	31.5	13.600
SWXA160-32	4		152.0	87.0	70.0	45	26.000
9000 lb							
SWXAXXS-04	½	See Note (1)	46.5	6.4	23.0	16	1.615
SWXAXXS-06	¾		56.5	11.0	28.0	16	2.113
SWXAXXS-08	1		63.5	15.2	33.0	18	3.896
SWXAXXS-10	1¼		76.0	22.7	40.0	20	6.298
SWXAXXS-12	1½		92.0	27.9	42.0	22	9.280
SWXAXXS-16	2		110.0	38.1	54.0	24	18.741
SWXAXXS-20	2½		121.0	45.0	66.0	24	25.702
SWXAXXS-24	3		146.0	58.4	70.0	31.5	33.761

(1) For the 'Bore'(M) other than standard pipe outside diameter.
-Dimensions are in millimeters.
-Dimensional Tolerances See ANSI B16.11 or JIS B2316

Full Coupllong
SWFC

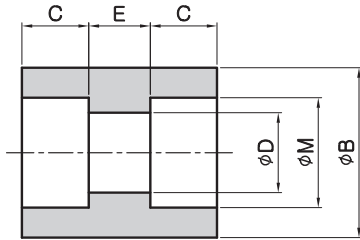

Part No.	Size	M	B	D	C	E	Unit Weight (kg)
3000 lb							
SWFC80-02	¼	See Note (1) To be specified by purchaser	22.0	9.4	10	6.4	0.05
SWFC80-03	⅜		26.0	12.7	10	6.4	0.12
SWFC80-04	½		32.0	16.1	10	9.6	0.12
SWFC80-06	¾		38.0	21.2	13	9.6	0.18
SWFC80-08	1		46.0	27.0	13	12.7	0.26
SWFC80-10	1¼		55.0	35.4	13	12.7	0.35
SWFC80-12	1½		63.0	41.2	13	12.7	0.47
SWFC80-16	2		75.0	52.7	16	19.1	0.81
SWFC80-20	2½		95.0	65.3	16	19.1	1.25
SWFC80-24	3		110.0	78.0	16	19.1	1.53
SWFC80-32	4	140.0	102.0	19	19.1	2.91	
6000 lb							
SWFC160-04	½	See Note (1)	35.0	12.0	10	9.6	0.170
SWFC160-06	¾		42.0	15.8	13	9.6	0.249
SWFC160-08	1		50.0	21.0	13	12.7	0.420
SWFC160-10	1¼		60.0	29.7	13	12.7	0.525
SWFC160-12	1½		68.0	34.2	13	12.7	0.665
SWFC160-16	2		85.0	43.1	16	19.1	1.240
SWFC160-20	2½		100.0	54.0	16	19.1	1.640
SWFC160-24	3		114.3	67.7	16	19.1	2.746
SWFC160-32	4		160.0	87.0	19	19.1	4.679
9000 lb							
SWFCXXS-04	½	See Note (1)	42.0	6.4	10	9.6	0.270
SWFCXXS-06	¾		48.0	11.0	13	9.6	0.327
SWFCXXS-08	1		60.0	15.2	13	12.7	0.518
SWFCXXS-10	1¼		70.0	22.7	13	12.7	0.813
SWFCXXS-12	1½		75.0	27.9	13	12.7	0.940
SWFCXXS-16	2		90.0	38.1	16	19.1	1.553
SWFCXXS-20	2½		110.0	45.0	16	19.1	2.430
SWFCXXS-24	3		130.0	58.4	16	19.1	3.721
SWFCXXS-32	4		160.0	80.3	19	19.1	5.137

-Note
(1) For the 'Bore'(M) other than standard pipe outside diameter.
-Dimensions are in millimeters.
-Dimensional Tolerances See ANSI B16.11 or JIS B2316

Half Coupling
SWHC

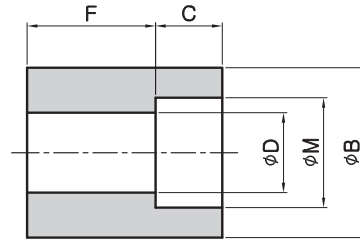

Part No.	Size	M	B	D	C	F	Unit Weight (kg)
3000 lb							
SWHC80-02	¼	See Note (1) To be specified by purchaser	22.0	9.4	10	15.7	0.058
SWHC80-03	⅜		26.0	12.7	10	17.5	0.073
SWHC80-04	½		32.0	16.1	10	22.4	0.138
SWHC80-06	¾		38.0	21.2	13	23.9	0.203
SWHC80-08	1		46.0	27.0	13	28.4	0.313
SWHC80-10	1¼		55.0	35.4	13	30.2	0.431
SWHC80-12	1½		63.0	41.2	13	31.8	0.593
SWHC80-16	2		75.0	52.7	16	41.1	1.280
SWHC80-20	2½		95.0	62.7	16	42.9	1.490
SWHC80-24	3		110.0	78.0	16	44.5	2.202
SWHC80-32	4	140.0	102.0	19	47.7	4.250	
6000 lb							
SWHC160-04	½	See Note (1)	35.0	12.0	10	22.4	0.193
SWHC160-06	¾		42.0	15.8	13	23.9	0.284
SWHC160-08	1		50.0	21.0	13	28.4	0.488
SWHC160-10	1¼		60.0	29.7	13	30.2	0.583
SWHC160-12	1½		68.0	34.2	13	31.8	0.640
SWHC160-16	2		85.0	43.1	16	41.1	1.726
SWHC160-20	2½		100.0	54.0	16	42.9	2.247
SWHC160-24	3		114.3	67.7	16	44.5	3.412
SWHC160-32	4		160.0	87.0	19	47.7	5.730
9000 lb							
SWHCXXS-04	½	See Note (1)	46.5	6.4	14	16	0.875
SWHCXXS-06	¾		56.5	11.0	22	16	1.369
SWHCXXS-08	1		63.5	15.2	22	18	1.725
SWHCXXS-10	1¼		76.0	22.7	24	20	2.931
SWHCXXS-12	1½		92.0	27.9	29	22	5.062
SWHCXXS-16	2		110.0	38.1	34	24	6.400
SWHCXXS-20	2½		121.0	45.0	34	24	7.925
SWHCXXS-24	3		146.0	58.4	42	31.5	11.569
SWHCXXS-32	4		160.0	80.3	42	31.5	11.569

Caps

SWCA

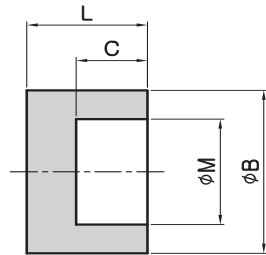

Part No.	Size	M	B	C	L	Unit Weight (kg)
3000 lb						
SWCA80-02	¼	See Note (1) To be specified by purchaser	22.0	10	20	0.048
SWCA80-03	⅜		26.0	10	20	0.076
SWCA80-04	½		32.0	10	20	0.100
SWCA80-06	¾		38.0	13	25	0.182
SWCA80-08	1		46.0	13	27	0.241
SWCA80-10	1¼		55.0	13	30	0.350
SWCA80-12	1½		63.0	13	30	0.612
SWCA80-16	2		75.0	16	36	0.880
SWCA80-20	2½		95.0	16	42	1.520
SWCA80-24	3		110.0	16	46	2.208
SWCA80-32	4	140.0	19	55	4.417	
6000 lb						
SWCA160-04	½	See Note (1)	35.0	10	26	0.055
SWCA160-06	¾		42.0	13	27	0.223
SWCA160-08	1		50.0	13	30	0.382
SWCA160-10	1¼		60.0	13	35	0.511
SWCA160-12	1½		68.0	13	36	0.735
SWCA160-16	2		85.0	16	39	1.289
SWCA160-20	2½		100.0	16	45	2.056
SWCA160-24	3		114.3	16	52	3.364
9000 lb						
SWCAXXS-04	½	See Note (1)	42.0	10	30	0.262
SWCAXXS-06	¾		48.0	13	30	0.320
SWCAXXS-08	1		60.0	13	33	0.520
SWCAXXS-10	1¼		70.0	13	40	1.256
SWCAXXS-12	1½		75.0	13	40	1.440
SWCAXXS-16	2		90.0	16	43	1.686
SWCAXXS-20	2½		110.0	16	50	2.986
SWCAXXS-24	3		130.0	16	58	4.666

Boss

SWBA

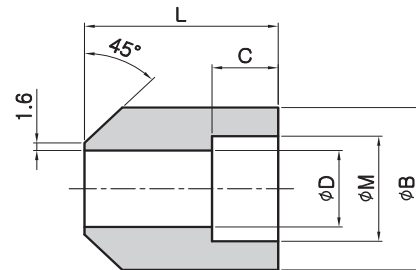

Part No.	Size	M	B	D	C	L	Unit Weight (kg)
3000 lb							
SWBA80-02	¼	See Note (1) To be specified by purchaser	22.0	9.4	10	30	0.09
SWBA80-03	⅜		26.0	12.7	10	30	0.14
SWBA80-04	½		32.0	16.1	10	33	0.24
SWBA80-06	¾		38.0	21.2	13	35	0.28
SWBA80-08	1		46.0	27.0	13	43	0.41
SWBA80-10	1¼		55.0	35.4	13	46	0.44
SWBA80-12	1½		63.0	41.2	13	50	0.63
SWBA80-16	2		75.0	52.7	16	57	1.09
6000 lb							
SWBA160-04	½	See Note (1)	35.0	12.0	10	33	0.45
SWBA160-06	¾		42.0	15.8	13	35	0.52
SWBA160-08	1		50.0	21.0	13	43	0.73
SWBA160-10	1¼		60.0	29.7	13	46	0.77
SWBA160-12	1½		68.0	34.2	13	50	0.12
SWBA160-16	2		85.0	43.1	16	57	1.82

-Note

(1) For the 'Bore'(M) other than standard pipe outside diameter.

-Dimensions are in millimeters.

-Dimensional Tolerances See ANSI B16.11 or JIS B2316

R.J Union
SWUA

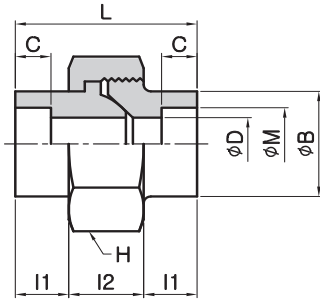

Part No.	Size	M	B	l_1	l_2	L	C	D	H	Unit Weight (kg)
3000 lb										
SWUA80-02	¼	See Note (1) To be specified by purchaser	21.0	11.5	18	41	10.0	9.4	35HEX	0.187
SWUA80-03	¾		25.0	14.0	18	46	10.0	12.7	40HEX	0.245
SWUA80-04	½		32.0	15.0	21	51	10.0	16.1	46HEX	0.430
SWUA80-06	¾		40.0	17.0	23	57	13.0	21.2	58HEX	0.620
SWUA80-08	1		48.0	19.5	25	64	13.0	27.0	65HEX	1.030
SWUA80-10	1¼		55.0	22.5	27	72	13.0	35.4	76OCT	1.150
SWUA80-12	1½		63.5	24.0	30	78	13.0	41.2	83OCT	1.530
SWUA80-16	2		76.0	26.0	36	88	16.0	52.7	103OCT	3.050
SWUA80-20	2½		95.0	34.0	42	110	18.0	62.7	124OCT	5.140
SWUA80-24	3		116.0	37.5	45	120	22.5	78.0	142OCT	7.120
SWUA80-32	4	148.0	45.0	50	140	25.0	102.0	176OCT	12.400	
6000 lb										
SWUA160-04	½	See Note (1)	40.0	17.0	23	57	13	12.0	56HEX	0.62
SWUA160-06	¾		44.5	19.5	25	64	13	15.8	65HEX	0.94
SWUA160-08	1		51.0	22.5	27	72	13	21.0	74OCT	1.98
SWUA160-10	1¼		57.2	24.0	30	78	16	29.7	83OCT	1.41
SWUA160-12	1½		71.5	26.0	36	88	16	34.2	103OCT	2.75
SWUA160-16	2		90.0	34.0	42	110	16	43.1	124OCT	5.05
SWUA160-20	2½		105.0	35.0	45	120	18	54.0	150OCT	6.87
SWUA160-24	3		125.0	45.0	50	140	22	67.7	176OCT	10.85

O-Ring Union
SWUAO

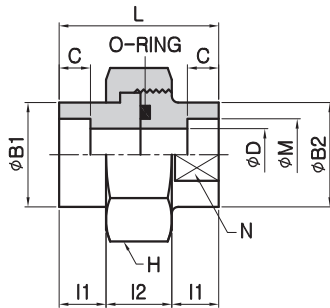

Part No.	Size	M	B1	B2	D	C	l_1	l_2	L	N	H	O-Ring	Unit Weight (kg)
3000 lb													
SWUAO80-02	½	See Note (1) To be specified by purchaser	22	24	10	10	10	18	38	21	35HEX	P18	0.160
SWUAO80-03	¾		27	30	12	10	10	18	38	26	41HEX	P20	0.228
SWUAO80-04	1		32	35	16	10	12	20	44	32	46HEX	G25	0.328
SWUAO80-06	1¼		38	42	20	13	12	26	50	38	54HEX	G30	0.535
SWUAO80-08	1½		47	52	25	13	15	26	56	46	63HEX	G35	0.786
SWUAO80-10	2		56	60	32	13	15	30	60	54	77HEX	G45	1.104
SWUAO80-12	2½		63	68	38	13	18	36	72	63	80OCT	G50	1.542
SWUAO80-16	3		76	82	48	17	18	36	72	77	95OCT	G65	2.080

(1) For the 'Bore'(M) other than standard pipe outside diameter.
-Dimensions are in millimeters.
-Dimensional Tolerances See ANSI B16.11 or JIS B2316

Male Connector
SWMC-R

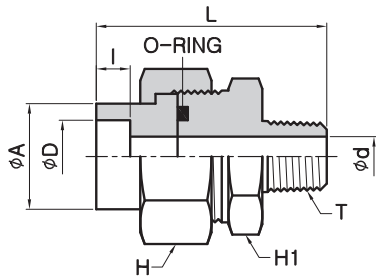

Part No.	Size	D	ℓ	d	A	L	H	H ₁	T (PT)	O-Ring		
SWMC02-02R	¼	14.3	10	7	22	54	HEX	36	HEX	30	¼	P18
SWMC02-03R	¼	14.3	10	9	22	55	HEX	36	HEX	30	⅜	P18
SWMC03-03R	⅜	17.8	10	9	27	56	HEX	41	HEX	36	⅜	P20
SWMC03-04R	⅜	17.8	10	12	27	56	HEX	41	HEX	36	½	P20
SWMC04-04R	½	22.2	10	12	32	60	HEX	46	HEX	41	½	G25
SWMC04-06R	½	22.2	10	16	32	66	HEX	46	HEX	41	¾	G25
SWMC06-06R	¾	27.7	13	16	37	72	HEX	55	HEX	46	¾	G30
SWMC06-08R	¾	27.7	13	20	37	75	HEX	55	HEX	46	1	G30
SWMC08-08R	1	34.5	13	20	44	82	HEX	60	HEX	55	1	G35
SWMC08-10R	1	34.5	13	25	44	84	HEX	60	HEX	55	1¼	G35
SWMC10-10R	1¼	43.2	13	25	54	90	OCT	75	OCT	65	1¼	G45
SWMC10-12R	1¼	43.2	13	32	54	91	OCT	75	OCT	65	1½	G45
SWMC12-12R	1½	49.1	13	32	63	99	OCT	85	OCT	75	1½	G50
SWMC12-16R	1½	49.1	13	38	63	103	OCT	85	OCT	75	2	G50
SWMC16-16R	2	61.1	16	38	76	103	OCT	100	OCT	90	2	G65

Male Connector
SWMC-G

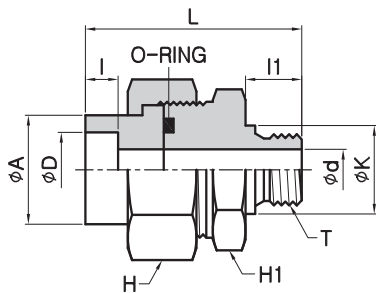

Part No.	Size	D	ℓ	ℓ ₁	d	A	L	K	H	H ₁	T (PT)	O-Ring		
SWMC02-02G	¼	14.3	10	12	7	22	54	18	HEX	36	HEX	30	¼	P18
SWMC02-03G	¼	14.3	10	12	9	22	55	21.5	HEX	36	HEX	30	⅜	P18
SWMC03-03G	⅜	17.8	10	12	9	27	56	21.5	HEX	41	HEX	36	⅜	P20
SWMC03-04G	⅜	17.8	10	14	12	27	56	25.5	HEX	41	HEX	36	½	P20
SWMC04-04G	½	22.2	10	14	12	32	60	25.5	HEX	46	HEX	41	½	G25
SWMC04-06G	½	22.2	10	16	16	32	66	31.5	HEX	46	HEX	41	¾	G25
SWMC06-06G	¾	27.7	13	16	16	37	72	31.5	HEX	55	HEX	46	¾	G30
SWMC06-08G	¾	27.7	13	18	20	37	75	38	HEX	55	HEX	46	1	G30
SWMC08-08G	1	34.5	13	18	20	44	82	38	HEX	60	HEX	55	1	G35
SWMC08-10G	1	34.5	13	20	25	44	84	48.5	HEX	60	HEX	55	1¼	G35
SWMC10-10G	1¼	43.2	13	20	25	54	90	48.5	OCT	75	OCT	65	1¼	G45
SWMC10-12G	1¼	43.2	13	22	32	54	91	53.5	OCT	75	OCT	65	1½	G45
SWMC12-12G	1½	49.1	13	22	32	63	99	53.5	OCT	85	OCT	75	1½	G50
SWMC12-16G	1½	49.1	13	24	38	63	103	66	OCT	85	OCT	75	2	G50
SWMC16-16G	2	61.1	16	24	38	76	103	66	OCT	100	OCT	90	2	G65

Reducing Insert

SWRM

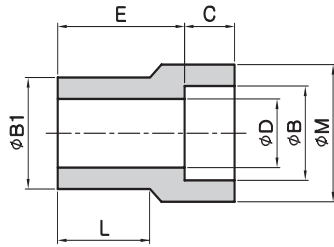

Type-1

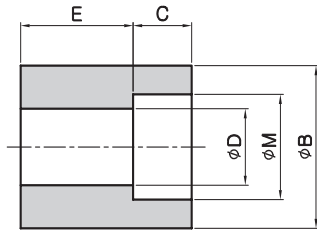

Type-2

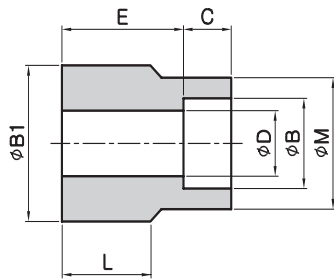

Type-3

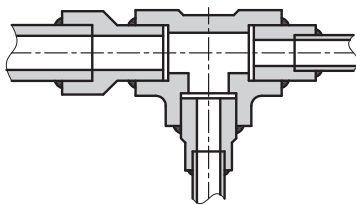

Application of Reducing Insert

Part No.	Size	Type	M	B	B ₁	C(Min.)	E	L	D	Unit Weight (kg)	
3000 lb											
SWRM0302-S80	3/8	1/4	1	22.2	See Note (1) To be specified by purchaser	See Note (1) To be specified by purchaser	9.6	21	16	9.4	0.051
SWRM0402-S80	1/2	1/4	2	-			9.6	15	-	9.4	0.052
SWRM0403-S80	1/2	3/8	1	25.4			9.6	24	20	12.7	0.086
SWRM0602-S80	3/4	1/4	3	-			9.6	19	7	9.4	0.109
SWRM0603-S80	3/4	3/8	2	-			9.6	19	-	12.7	0.697
SWRM0604-S80	3/4	1/2	1	31.8			9.6	26	22	16.1	0.146
SWRM0803-S80	1	3/4	3	25.4			9.6	22	7	12.7	0.161
SWRM0804-S80	1	1/2	2	-			9.6	22	-	16.1	0.183
SWRM0806-S80	1	3/4	1	38.1			12.7	29	23	21.4	0.208
SWRM1004-S80	1 1/4	1	3	31.8			9.6	24	7	16.1	0.273
SWRM1006-S80	1 1/4	3/4	2	-			12.7	24	-	21.4	0.286
SWRM1008-S80	1 1/4	1	1	46.0			12.7	32	24.5	27.2	0.436
SWRM1206-S80	1 1/2	3/4	3	38.1			12.7	26	8	21.4	0.348
SWRM1208-S80	1 1/2	1	2	-			12.7	26	-	27.2	0.384
SWRM1210-S80	1 1/2	1 1/4	1	55.0			12.7	35	27	35.5	0.463
SWRM1208-S80	2	1 1/2	3	46.0			12.7	29	8	27.2	0.615
SWRM1610-S80	2	1 1/4	2	-			12.7	29	-	35.5	0.647
SWRM1612-S80	2	1 1/2	1	65.0			12.7	37	29	41.2	0.661
SWRM2010-S80	2 1/2	2	3	55.0			12.7	35	8	35.5	1.183
SWRM2012-S80	2 1/2	1 1/2	3	65.0			12.7	35	8	41.2	1.107
SWRM2016-S80	2 1/2	2	1	76.0	15.9	39	30	52.7	1.200		
SWRM2412-S80	3	1 1/2	3	65.0	12.7	39	8	41.2	1.715		
SWRM2416-S80	3	2	3	75.0	15.9	39	10	52.7	1.542		
SWRM2420-S80	3	2 1/2	1	95.0	15.9	51	33.5	65.9	1.825		
6000 lb											
SWRM0302-S160	3/4	1/2	1	38.1	See Note (1) To be specified by purchaser	See Note (1) To be specified by purchaser	12.3	23	12.3	12.3	0.316
SWRM0402-S160	1	1/2	1	38.1			12.3	24	12.3	12.3	0.354
SWRM0403-S160	1	3/4	1	46.0			16.2	26	16.2	16.2	0.526
SWRM0602-S160	1 1/4	1/2	2	-			12.3	-	12.3	12.3	0.415
SWRM0603-S160	1 1/4	3/4	1	46.0			16.2	28	16.2	16.2	0.557
SWRM0604-S160	1 1/4	1	1	55.0			21.2	28	21.2	21.2	0.765
SWRM0803-S160	1 1/2	3/4	2	-			16.2	-	16.2	16.2	0.619
SWRM0804-S160	1 1/2	1	1	55.0			21.2	28	21.2	21.2	0.723
SWRM0806-S160	1 1/2	1 1/4	1	62.0			29.9	32	29.9	29.9	0.957
SWRM1004-S160	2	1	3	-			21.2	8	21.2	21.2	1.026
SWRM1006-S160	2	1 1/4	1	62.0			29.9	34	29.9	29.9	1.137
SWRM1008-S160	2	1 1/2	1	75.0			34.4	34	34.4	34.4	0.911
SWRM1206-S160	2 1/2	1 1/4	3	62.0			29.9	8	29.9	29.9	1.478
SWRM1208-S160	2 1/2	1 1/2	2	-			34.4	-	34.4	34.4	1.881
SWRM1210-S160	2 1/2	2	1	95.0			43.1	36	43.1	43.1	2.918
SWRM1208-S160	3	1 1/2	3	75.0			34.4	8	34.4	34.4	2.370
SWRM1610-S160	3	2	2	95.0			43.1	-	43.1	43.1	3.313
SWRM1612-S160	3	2 1/2	1	110.0			57.3	38	57.3	57.3	3.562

(1) For the 'Bore'(M) other than standard pipe outside diameter.

-Dimensions are in millimeters.

-Dimensional Tolerances See ANSI B16.11 or JIS B2316

Reducing Coupling
SWRC

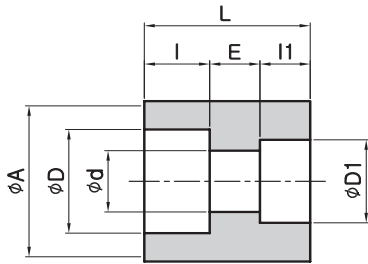

Part No.	Size	D	D ₁	ℓ	ℓ ₁	d	A	E	L	
3000 lb										
SWRC0302-S80	3/8	1/4	17.8	14.3	10	10	9.4	26	6.4	26.4
SWRC0402-S80	1/2	1/4	22.2	14.3	10	10	9.4	32	9.5	29.5
SWRC0403-S80	1/2	3/8	22.2	17.8	10	10	12.7	32	9.5	29.5
SWRC0602-S80	3/4	1/4	27.7	14.3	13	10	9.4	38	9.5	32.5
SWRC0603-S80	3/4	3/8	27.7	17.8	13	10	12.7	38	9.5	32.5
SWRC0604-S80	3/4	1/2	27.7	22.2	13	10	16.1	38	9.5	32.5
SWRC0803-S80	1	3/8	34.5	17.8	13	10	12.7	46	12.7	35.7
SWRC0804-S80	1	1/2	34.5	22.2	13	10	16.1	46	12.7	35.7
SWRC0806-S80	1	3/4	34.5	27.2	13	13	21.4	46	12.7	38.7
SWRC1004-S80	1 1/4	1/2	43.2	22.2	13	10	16.1	55	12.7	35.7
SWRC1006-S80	1 1/4	3/4	43.2	27.7	13	13	21.4	55	12.7	38.7
SWRC1008-S80	1 1/4	1	43.2	34.5	13	13	27.2	55	12.7	38.7
SWRC1206-S80	1 1/2	3/4	49.1	27.7	13	13	21.4	63	12.7	38.7
SWRC1208-S80	1 1/2	1	49.1	34.5	13	13	27.2	63	12.7	38.7
SWRC1210-S80	1 1/2	1 1/4	49.1	43.2	13	13	35.5	63	12.7	38.7
SWRC1608-S80	2	1	61.1	34.5	16	13	27.2	75	19.1	48.1
SWRC1610-S80	2	1 1/4	61.1	43.2	16	13	35.5	75	19.1	48.1
SWRC1612-S80	2	1 1/2	61.1	49.1	16	13	41.2	75	19.1	48.1

6000 lb										
SWRC0604-S160	3/4		27.7	22.2	13	13	12.3	42	9.5	35.5
SWRC0804-S160	1		34.5	22.2	13	13	12.3	50	12.7	38.7
SWRC0806-S160	1		34.5	27.7	13	13	16.2	50	12.7	38.7
SWRC1004-S160	1 1/4		43.2	22.2	13	13	12.3	60	12.7	38.7
SWRC1006-S160	1 1/4		43.2	27.7	13	13	16.2	60	12.7	38.7
SWRC1008-S160	1 1/4		43.2	34.5	13	13	21.2	60	12.7	38.7
SWRC1206-S160	1 1/2		49.1	27.7	16	13	16.2	68	12.7	41.7
SWRC1208-S160	1 1/2		49.1	34.5	16	13	21.2	68	12.7	41.7
SWRC1210-S160	1 1/2		49.1	43.2	16	13	29.9	68	12.7	41.7
SWRC1608-S160	2		61.1	34.5	16	13	21.2	85	19.1	48.1
SWRC1610-S160	2		61.1	43.2	16	13	29.9	85	19.1	48.1
SWRC1612-S160	2		61.1	49.1	16	16	34.4	85	19.1	51.1

Boss Type R
SWBR

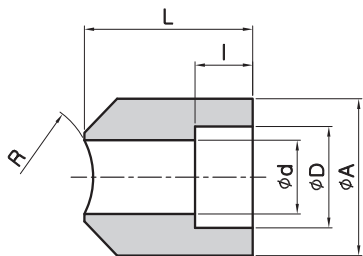

Part No.	Size	D	ℓ	d	A	R	L
3000 lb							
SWBR02-S80	1/4	14.3	10	9.4	22	25	30
SWBR03-S80	3/8	17.8	10	12.7	26	25	30
SWBR04-S80	1/2	22.2	10	16.1	32	30	33
SWBR06-S80	3/4	27.7	13	21.4	38	30	35
SWBR08-S80	1	34.5	13	27.2	46	40	43
SWBR10-S80	1 1/4	43.2	13	35.5	55	45	46
SWBR12-S80	1 1/2	49.1	13	41.2	63	55	50
SWBR16-S80	2	61.1	16	52.7	75	60	57
6000 lb							
SWBR04-S160	1/2	22.2	13	12.3	35	30	33
SWBR06-S160	3/4	27.7	13	16.2	42	30	35
SWBR08-S160	1	34.5	13	21.2	55	40	43
SWBR10-S160	3/4	43.2	13	29.9	60	45	46
SWBR12-S160	1	49.1	16	34.4	70	55	50
SWBR16-S160	1 1/4	61.1	16	43.1	85	60	57

90° Elbow
SLA

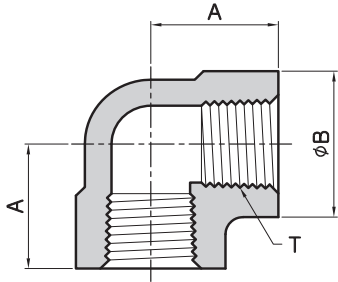

Part No.	Size T	B	A	Unit Weight (kg)
2000 lb				
SLA40-02	¼	23	25.4	0.13
SLA40-03	⅜	26.5	25.4	0.12
SLA40-04	½	34.0	28.5	0.23
SLA40-06	¾	38.5	33.5	0.36
SLA40-08	1	46.5	38.1	0.55
SLA40-10	1¼	56.5	44.5	0.95
SLA40-12	1½	63.5	50.8	1.12
SLA40-16	2	76.0	60.5	1.96
SLA40-20	2½	92.0	76.0	3.25
SLA40-24	3	110.0	86.0	5.64
SLA40-26	3½	121.0	95.5	6.92
SLA40-32	4	146.0	106.5	10.43
3000 lb				
SLA80-02	¼	26.5	25.4	0.120
SLA80-03	⅜	34.0	28.5	0.235
SLA80-04	½	38.5	33.5	0.390
SLA80-06	¾	46.5	38.1	0.570
SLA80-08	1	56.5	44.5	0.990
SLA80-10	1¼	63.5	50.8	1.260
SLA80-12	1½	76.0	60.5	2.125
SLA80-16	2	84.0	64.0	3.520
SLA80-20	2½	110.0	83.0	5.460
SLA80-24	3	121.0	95.5	8.000
SLA80-26	3½	146.0	106.5	11.230
SLA80-32	4	152.0	114.3	13.500
6000 lb				
SLA160-03	⅜	38.5	33.5	0.40
SLA160-04	½	46.5	38.5	0.68
SLA160-06	¾	56.5	44.5	1.13
SLA160-08	1	63.5	50.8	1.59
SLA160-10	1¼	76.0	60.5	2.60
SLA160-12	1½	84.0	64.0	4.32
SLA160-16	2	110.0	85.0	7.33
SLA160-20	2½	121.0	95.5	9.25
SLA160-24	3	146.0	106.5	12.05
SLA160-26	3½	152.0	114.3	14.30
SLA160-32	4	152.0	114.3	14.10

45° Elbow
SLB

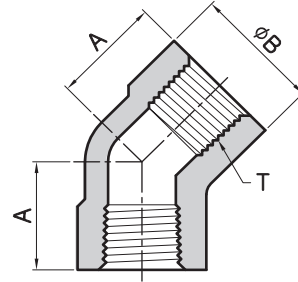

Part No.	Size T	B	A	Unit Weight (kg)
2000 lb				
SLB40-02	¼	23	19.1	0.16
SLB40-03	⅜	26.5	19.1	0.13
SLB40-04	½	34.0	26.0	0.25
SLB40-06	¾	38.5	28.6	0.32
SLB40-08	1	46.5	30.0	0.43
SLB40-10	1¼	56.5	33.3	0.75
SLB40-12	1½	63.5	42.0	1.06
SLB40-16	2	76.0	46.0	1.49
SLB40-20	2½	92.0	53.0	2.45
SLB40-24	3	110.0	64.0	4.00
SLB40-26	3½	121.0	64.0	5.12
SLB40-32	4	146.0	80.0	8.68
3000 lb				
SLB80-02	¼	26.5	19.1	0.16
SLB80-03	⅜	34.0	26.0	0.28
SLB80-04	½	38.5	28.6	0.38
SLB80-06	¾	46.5	30.0	0.51
SLB80-08	1	56.5	33.3	1.03
SLB80-10	1¼	63.5	42.0	1.22
SLB80-12	1½	76.0	46.0	2.36
SLB80-16	2	84.0	53.0	3.66
SLB80-20	2½	110.0	64.0	6.12
SLB80-24	3	121.0	64.0	6.12
SLB80-26	3½	146.0	80.0	8.40
SLB80-32	4	152.0	80.0	11.30
6000 lb				
SLB160-03	⅜	38.5	28.6	0.45
SLB160-04	½	46.5	30.0	0.72
SLB160-06	¾	56.5	33.3	1.00
SLB160-08	1	63.5	42.0	1.56
SLB160-10	1¼	76.0	46.0	2.29
SLB160-12	1½	84.0	53.0	3.80
SLB160-16	2	110.0	64.0	5.76
SLB160-20	2½	121.0	64.0	7.20
SLB160-24	3	146.0	80.0	11.30
SLB160-26	3½	152.0	80.0	13.20
SLB160-32	4	152.0	80.0	11.80

90° Elbow
STA

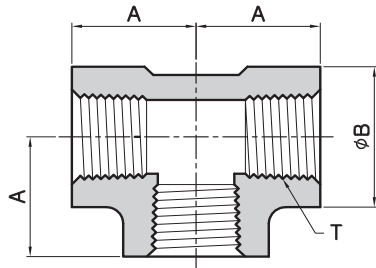

Part No.	Size T	B	A	Unit Weight (kg)
2000 lb				
STA40-02	¼	23	25.4	0.14
STA40-03	⅜	26.5	25.4	0.18
STA40-04	½	34.0	28.5	0.26
STA40-06	¾	38.5	33.5	0.43
STA40-08	1	46.5	38.1	0.65
STA40-10	1¼	56.5	44.5	0.91
STA40-12	1½	63.5	50.8	1.25
STA40-16	2	76.0	60.5	2.10
STA40-20	2½	92.0	76.0	3.94
STA40-24	3	110.0	86.0	5.98
STA40-26	3½	121.0	95.5	7.41
STA40-32	4	146.0	106.5	12.36
3000 lb				
STA80-02	¼	26.5	25.4	0.18
STA80-03	⅜	34.0	28.5	0.32
STA80-04	½	38.5	33.5	0.52
STA80-06	¾	46.5	38.1	0.73
STA80-08	1	56.5	44.5	1.26
STA80-10	1¼	63.5	50.8	1.65
STA80-12	1½	76.0	60.5	2.81
STA80-16	2	84.0	64.0	4.35
STA80-20	2½	110.0	83.0	6.26
STA80-24	3	121.0	95.5	10.05
STA80-26	3½	146.0	106.5	14.62
STA80-32	4	152.0	114.3	16.50
6000 lb				
STA160-03	⅜	38.5	33.5	0.59
STA160-04	½	46.5	38.5	0.96
STA160-06	¾	56.5	44.5	1.50
STA160-08	1	63.5	50.8	2.10
STA160-10	1¼	76.0	60.5	3.30
STA160-12	1½	84.0	64.0	5.72
STA160-16	2	110.0	85.0	9.64
STA160-20	2½	121.0	95.5	13.40
STA160-24	3	146.0	106.5	16.15
STA160-26	3½	152.0	114.3	18.23
STA160-32	4	152.0	114.3	16.70

Cross
SXA

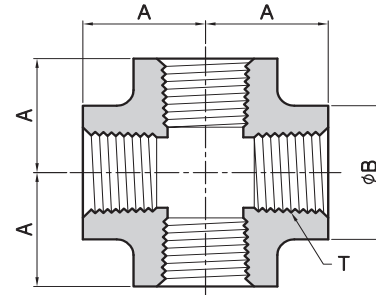

Part No.	Size T	B	A	Unit Weight (kg)
2000 lb				
SXA40-02	¼	23	25.4	0.14
SXA40-03	⅜	26.5	25.4	0.22
SXA40-04	½	34.0	28.5	0.37
SXA40-06	¾	38.5	33.5	0.52
SXA40-08	1	46.5	38.1	0.79
SXA40-10	1¼	56.5	44.5	1.28
SXA40-12	1½	63.5	50.8	1.62
SXA40-16	2	76.0	60.5	2.62
SXA40-20	2½	92.0	76.0	4.66
SXA40-24	3	110.0	86.0	7.10
SXA40-26	3½	121.0	95.5	8.85
SXA40-32	4	146.0	106.5	14.83
3000 lb				
SXA80-02	¼	26.5	25.4	0.23
SXA80-03	⅜	34.0	28.5	0.40
SXA80-04	½	38.5	33.5	0.63
SXA80-06	¾	46.5	38.1	0.93
SXA80-08	1	56.5	44.5	1.47
SXA80-10	1¼	63.5	50.8	1.78
SXA80-12	1½	76.0	60.5	3.42
SXA80-16	2	84.0	64.0	5.50
SXA80-20	2½	110.0	83.0	7.66
SXA80-24	3	121.0	95.5	11.21
SXA80-26	3½	146.0	106.5	16.72
SXA80-32	4	152.0	114.3	19.00
6000 lb				
SXA160-03	⅜	38.5	33.5	0.67
SXA160-04	½	46.5	38.5	1.12
SXA160-06	¾	56.5	44.5	1.90
SXA160-08	1	63.5	50.8	2.90
SXA160-10	1¼	76.0	60.5	4.20
SXA160-12	1½	84.0	64.0	6.65
SXA160-16	2	110.0	85.0	10.00
SXA160-20	2½	121.0	95.5	16.00
SXA160-24	3	146.0	106.5	19.87
SXA160-26	3½	152.0	114.3	28.10
SXA160-32	4	152.0	114.3	24.60

Full Coupling
SFC

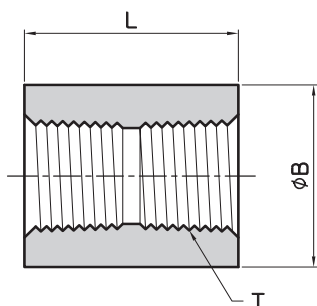

Part No.	Size T	B	L	Unit Weight (kg)
3000 lb				
SFC80-02	¼	22.0	35.1	0.050
SFC80-03	⅜	25.0	38.1	0.061
SFC80-04	½	30.0	48.0	0.142
SFC80-06	¾	35.0	51.0	0.218
SFC80-08	1	45.0	61.0	0.418
SFC80-10	1¼	57.0	67.0	0.720
SFC80-12	1½	63.5	80.0	1.065
SFC80-16	2	76.0	86.0	1.400
SFC80-20	2½	92.0	92.0	2.550
SFC80-24	3	108.0	108.0	3.830
SFC80-26	3½	127.0	114.3	5.720
SFC80-32	4	140.0	121.0	6.350
6000 lb				
SFC160-02	¼	25.0	35.0	0.120
SFC160-03	⅜	32.0	38.0	0.180
SFC160-04	½	38.1	48.0	0.280
SFC160-06	¾	45.0	51.0	0.450
SFC160-08	1	57.0	61.0	0.800
SFC160-10	1¼	63.5	67.0	1.400
SFC160-12	1½	76.0	80.0	1.950
SFC160-16	2	92.0	86.0	2.800
SFC160-20	2½	108.0	92.0	3.800
SFC160-24	3	127.0	108.0	6.010
SFC160-26	3½	140.0	114.3	8.250
SFC160-32	4	160.0	121.0	10.700

Half Coupling
SHC

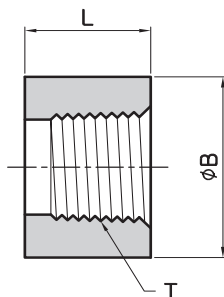

Part No.	Size T	B	L	Unit Weight (kg)
3000 lb				
SHC80-02	¼	22.0	17.5	0.025
SHC80-03	⅜	25.0	19.0	0.030
SHC80-04	½	30.0	24.0	0.070
SHC80-06	¾	35.0	25.5	0.100
SHC80-08	1	45.0	30.5	0.210
SHC80-10	1¼	57.0	33.5	0.365
SHC80-12	1½	63.5	40.0	0.520
SHC80-16	2	76.0	43.0	0.690
SHC80-20	2½	92.0	46.0	1.250
SHC80-24	3	108.0	54.0	1.840
SHC80-26	3½	127.0	57.5	2.860
SHC80-32	4	140.0	60.5	3.510
6000 lb				
SHC160-02	¼	25.0	17.5	0.06
SHC160-03	⅜	32.0	19.0	0.09
SHC160-04	½	38.1	24.0	0.14
SHC160-06	¾	45.0	25.5	0.23
SHC160-08	1	57.0	30.5	0.37
SHC160-10	1¼	63.5	33.5	0.70
SHC160-12	1½	76.0	40.0	0.90
SHC160-16	2	92.0	43.0	1.22
SHC160-20	2½	108.0	46.0	1.85
SHC160-24	3	127.0	54.0	2.95
SHC160-26	3½	140.0	57.5	4.12
SHC160-32	4	160.0	60.5	5.40

CAP
SCA

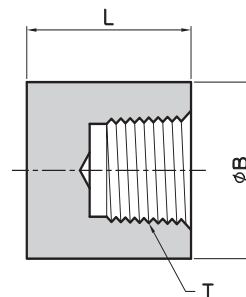

Part No.	Size T	B	L	Unit Weight (kg)
3000 lb				
SCA80-02	¼	22.0	25	0.05
SCA80-03	⅜	25.0	25	0.08
SCA80-04	½	30.0	32	0.12
SCA80-06	¾	35.0	37	0.20
SCA80-08	1	45.0	41	0.31
SCA80-10	1¼	57.0	44	0.60
SCA80-12	1½	63.5	44	0.73
SCA80-16	2	76.0	48	1.05
SCA80-20	2½	92.0	60	2.27
SCA80-24	3	108.0	65	3.83
SCA80-26	3½	127.0	68	4.52
SCA80-32	4	140.0	68	6.35
6000 lb				
SCA160-02	¼	25.0	27	0.09
SCA160-03	⅜	32.0	27	0.14
SCA160-04	½	38.1	33	0.25
SCA160-06	¾	45.0	38	0.36
SCA160-08	1	57.0	43	0.70
SCA160-10	1¼	63.5	46	0.80
SCA160-12	1½	76.0	48	1.28
SCA160-16	2	92.0	51	2.16
SCA160-20	2½	108.0	64	2.72
SCA160-24	3	127.0	68	4.95
SCA160-26	3½	140.0	70	6.84
SCA160-32	4	160.0	75	9.21

Hex Head Pulg
SPB

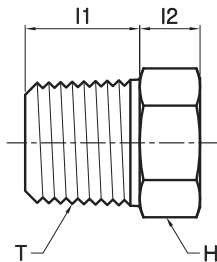

Part No.	Size T	l_1	l_2	H	Unit Weight (kg)
3000 lb					
SPB-01	1/8	11	6.3	11.0	0.03
SPB-02	1/4	13	6.3	14.0	0.03
SPB-03	3/8	14	8.0	19.0	0.06
SPB-04	1/2	18	8.0	22.0	0.08
SPB-06	3/4	19	10.0	27.0	0.14
SPB-08	1	21	10.0	35.0	0.22
SPB-10	1 1/4	22	14.0	46.0	0.51
SPB-12	1 1/2	24	16.0	50.0	0.62
SPB-16	2	25	18.0	63.5	1.02
SPB-20	2 1/2	32	19.0	76.2	1.76
SPB-24	3	40	21.0	99.0	2.66
SPB-26	3 1/2	41	22.0	103.0	3.72
SPB-32	4	42	32.0	117.0	5.90

Squire Pulg
SPD

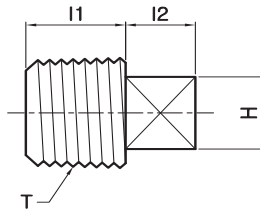

Part No.	Size T	l_1	l_2	H	Unit Weight (kg)
3000 lb					
SPD-01	1/8	9.9	6.6	7.0	0.007
SPD-02	1/4	13.0	6.6	9.0	0.014
SPD-03	3/8	13.0	7.9	12.0	0.028
SPD-04	1/2	15.0	9.9	14.0	0.057
SPD-06	3/4	16.0	11.0	17.0	0.085
SPD-08	1	20.1	13.0	19.0	0.140
SPD-10	1 1/4	21.1	15.0	24.0	0.255
SPD-12	1 1/2	21.1	16.0	27.0	0.397
SPD-16	2	23.1	18.0	32.0	0.680
SPD-20	2 1/2	27.0	20.0	38.1	1.020
SPD-24	3	29.0	21.0	42.9	1.301
SPD-26	3 1/2	30.0	22.2	47.6	2.050
SPD-32	4	32.0	25.0	63.5	3.257

Round Plug
SPE

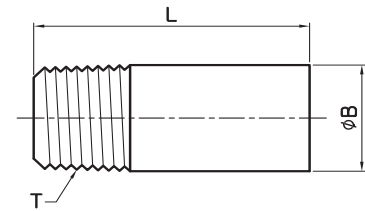

Part No.	Size T	B	L	Unit Weight (kg)
3000 lb				
SPE-01	1/8	10.3	35.0	0.057
SPE-02	1/4	13.5	41.3	0.057
SPE-03	3/8	17.5	41.3	0.085
SPE-04	1/2	21.4	44.5	0.170
SPE-06	3/4	27.0	44.5	0.170
SPE-08	1	33.4	50.8	0.340
SPE-10	1 1/4	42.9	50.8	0.340
SPE-12	1 1/2	48.4	50.8	0.710
SPE-16	2	60.3	63.5	1.361
SPE-20	2 1/2	73.0	70.0	2.155
SPE-24	3	88.9	70.0	3.456
SPE-26	3 1/2	101.6	76.2	4.216
SPE-32	4	114.3	76.2	5.838

Reducing Coupling
SRC

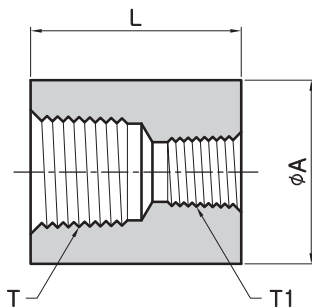

Part No.	T (PT)	T ₁ (PT)	A	L
SRC02-01R	1/4	1/8	22	35.1
SRC03-02R	3/8	1/4	25	38.1
SRC04-02R	1/2	1/4	30	47.8
SRC04-03R	1/2	3/8	30	47.8
SRC06-02R	3/4	1/4	35	50.8
SRC06-03R	3/4	3/8	35	50.8
SRC06-04R	3/4	1/2	35	50.8
SRC08-03R	1	3/8	45	60.5
SRC08-04R	1	1/2	45	60.5
SRC08-06R	1	3/4	45	60.5
SRC10-04R	1 1/4	1/2	60	66.5
SRC10-06R	1 1/4	3/4	60	66.5
SRC10-08R	1 1/4	1	60	66.5
SRC12-06R	1 1/2	3/4	65	79.3
SRC12-08R	1 1/2	1	65	79.3
SRC12-10R	1 1/2	1 1/4	65	79.3
SRC16-08R	2	1	80	85.9
SRC16-10R	4	1 1/4	80	85.9

Hex Nipple
SNA

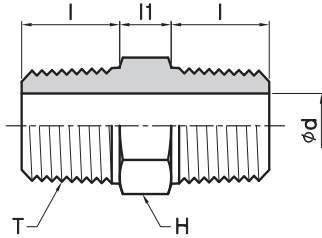

Part No.	T (PT)	d	H	l	l_1
SNA-01R	$\frac{1}{8}$	4	HEX 12	10	6
SNA-02R	$\frac{1}{4}$	7	HEX 17	14	8
SNA-03R	$\frac{3}{8}$	9	HEX 19	15	8
SNA-04R	$\frac{1}{2}$	12	HEX 22	19	9
SNA-06R	$\frac{3}{4}$	16	HEX 27	21	10
SNA-08R	1	20	HEX 36	24	11
SNA-10R	$1\frac{1}{4}$	28	HEX 46	27	12
SNA-12R	$1\frac{1}{2}$	32	HEX 50	27	14
SNA-16R	2	40	HEX 65	31	16

Reducing Nipple
SNR

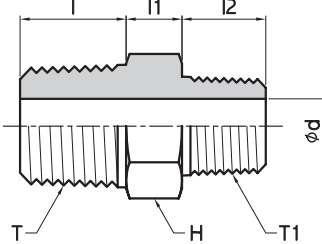

Part No.	T (PT)	x	T1 (PT)	d	H	l	l_1	l_2
SNR02-01R	$\frac{1}{4}$	x	$\frac{1}{8}$	4	HEX 17	14	8	10
SNR03-02R	$\frac{3}{8}$	x	$\frac{1}{4}$	7	HEX 19	15	8	14
SNR04-02R	$\frac{1}{2}$	x	$\frac{1}{4}$	7	HEX 22	19	9	14
SNR04-03R	$\frac{1}{2}$	x	$\frac{3}{8}$	9	HEX 22	19	9	15
SNR06-02R	$\frac{3}{4}$	x	$\frac{1}{4}$	7	HEX 27	21	10	14
SNR06-03R	$\frac{3}{4}$	x	$\frac{3}{8}$	9	HEX 27	21	10	15
SNR06-04R	$\frac{3}{4}$	x	$\frac{1}{2}$	12	HEX 27	21	10	19
SNR08-03R	1	x	$\frac{3}{8}$	9	HEX 36	24	11	15
SNR08-04R	1	x	$\frac{1}{2}$	12	HEX 36	24	11	19
SNR08-06R	1	x	$\frac{3}{4}$	16	HEX 36	24	11	21
SNR10-04R	$1\frac{1}{4}$	x	$\frac{1}{2}$	12	HEX 46	27	12	19
SNR10-06R	$1\frac{1}{4}$	x	$\frac{3}{4}$	16	HEX 46	27	12	21
SNR10-08R	$1\frac{1}{4}$	x	1	20	HEX 46	27	12	24
SNR12-06R	$1\frac{1}{2}$	x	$\frac{3}{4}$	16	HEX 50	27	14	21
SNR12-08R	$1\frac{1}{2}$	x	1	20	HEX 50	27	14	24
SNR12-10R	$1\frac{1}{2}$	x	$1\frac{1}{4}$	28	HEX 50	27	14	27
SNR16-08R	2	x	1	20	HEX 65	31	16	24
SNR16-10R	2	x	$1\frac{1}{4}$	28	HEX 65	31	16	27
SNR16-12R	2	x	$1\frac{1}{2}$	32	HEX 65	31	16	27

Reducing Nipple
SSA

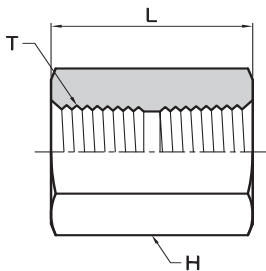

Part No.	T (PT)	H	L
SSA-01R	$\frac{1}{8}$	HEX 19	30
SSA-02R	$\frac{1}{4}$	HEX 22	30
SSA-03R	$\frac{3}{8}$	HEX 24	30
SSA-04R	$\frac{1}{2}$	HEX 32	40
SSA-06R	$\frac{3}{4}$	HEX 36	42
SSA-08R	1	HEX 46	50
SSA-10R	$1\frac{1}{4}$	HEX 55	55
SSA-12R	$1\frac{1}{2}$	HEX 65	55
SSA-16R	2	HEX 75	64

Hex Bushing

SHB

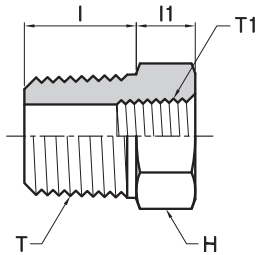

Part No.	T (PT)	x	T1 (PT)	H	l	l ₁
SHB02-01R	¼	x	⅙	HEX 17	14	8
SHB03-02R	⅜	x	¼	HEX 19	15	8
SHB04-02R	½	x	¼	HEX 24	19	9
SHB04-03R	½	x	⅜	HEX 24	19	9
SHB06-02R	¾	x	¼	HEX 30	21	10
SHB06-03R	¾	x	⅜	HEX 30	21	10
SHB06-04R	¾	x	½	HEX 30	21	10
SHB08-02R	1	x	¼	HEX 36	24	11
SHB08-03R	1	x	⅜	HEX 36	24	11
SHB08-04R	1	x	½	HEX 36	24	11
SHB08-06R	1	x	¾	HEX 36	24	11
SHB10-04R	1¼	x	½	HEX 46	27	12
SHB10-06R	1¼	x	¾	HEX 46	27	12
SHB10-08R	1¼	x	1	HEX 46	27	12
SHB12-04R	1½	x	½	HEX 50	27	14
SHB12-06R	1½	x	¾	HEX 50	27	14
SHB12-08R	1½	x	1	HEX 50	27	14
SHB12-10R	1½	x	1¼	HEX 50	27	14
SHB16-06R	2	x	¾	HEX 65	31	16
SHB16-08R	2	x	1	HEX 65	31	16
SHB16-10R	2	x	1¼	HEX 65	31	16
SHB16-12R	2	x	1½	HEX 65	31	16

Boss Type A

SBA

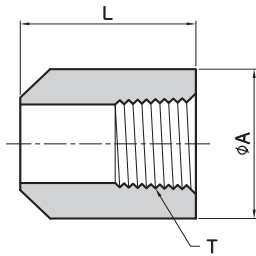

Part No.	T (PT)	A	L
SBA-02R	¼	22	30
SBA-03R	⅜	26	30
SBA-04R	½	32	33
SBA-06R	¾	38	35
SBA-08R	1	46	43
SBA-10R	1¼	55	46
SBA-12R	1½	65	50
SBA-16R	2	75	57

Boss Type R

SBR

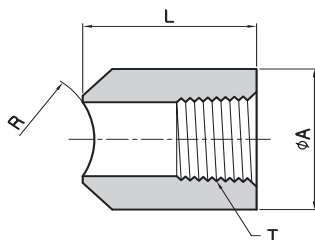

Part No.	T (PT)	A	L	R
SBA-02R	¼	22	30	25
SBA-03R	⅜	26	30	25
SBA-04R	½	32	33	30
SBA-06R	¾	38	35	30
SBA-08R	1	46	43	40
SBA-10R	1¼	55	46	45
SBA-12R	1½	65	50	55
SBA-16R	2	75	57	60

R.J Union

SUA

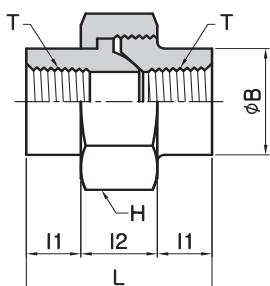

Part No.	Size T	B	l ₁	l ₂	L	H	Unit Weight (kg)
3000 lb							
SUA80-02	¼	21.0	11.5	18	41	HEX 35	0.19
SUA80-03	⅜	25.0	14.0	18	46	HEX 40	0.25
SUA80-04	½	32.0	15.0	21	51	HEX 46	0.43
SUA80-06	¾	40.0	17.0	23	57	HEX 58	0.62
SUA80-08	1	48.0	19.5	25	64	HEX 65	1.03
SUA80-10	1¼	55.5	22.5	27	72	OCT 76	1.15
SUA80-12	2	63.5	24.0	30	78	OCT 83	1.54
SUA80-16	2	76.0	26.0	36	88	OCT 103	3.05
SUA80-20	2½	95.0	34.0	42	110	OCT 124	5.14
SUA80-24	3	116.0	37.0	45	120	OCT 150	7.12
SUA80-32	4	148.0	45.0	50	140	OCT 180	12.40
6000 lb							
SUA160-02	¼	25.4	13.5	19	46	HEX 40	0.25
SUA160-03	⅜	32.0	15.0	21	51	HEX 46	0.43
SUA160-04	½	40.0	17.0	23	57	HEX 56	0.62
SUA160-06	¾	44.5	19.5	25	64	HEX 65	0.94
SUA160-08	1	51.0	22.5	27	72	OCT 74	1.08
SUA160-10	1¼	57.2	24.0	30	78	OCT 83	1.41
SUA160-12	1½	71.5	26.0	36	88	OCT 103	2.75
SUA160-16	2	90.0	34.0	42	110	OCT 124	5.05
SUA160-20	2½	105.0	37.5	45	120	OCT 150	6.87
SUA160-24	3	125.0	45.0	50	140	OCT 180	10.85

O-Ring Union

SUAO

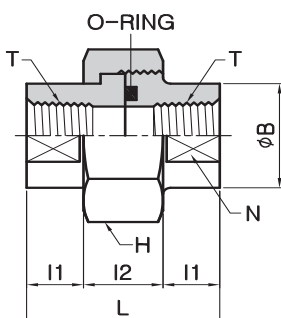

Part No.	Size T	B	l ₁	l ₂	L	N	H	O-Ring	Unit Weight (kg)
3000 lb									
SUAO80-02	¼	22	10	18	38	21	HEX 35	P18	0.160
SUAO80-03	⅜	27	10	18	38	26	HEX 41	P20	0.215
SUAO80-04	½	32	12	20	44	32	HEX 46	G25	0.312
SUAO80-06	¾	38	12	26	50	38	HEX 54	G30	0.477
SUAO80-08	1	47	15	26	56	46	HEX 63	G35	0.764
SUAO80-10	1¼	56	15	30	60	54	HEX 77	G45	1.106
SUAO80-12	1½	63	18	36	72	63	OCT 80	G50	1.327
SUAO80-16	2	76	18	36	72	77	OCT 95	G65	1.856

Weldolet
SWLT

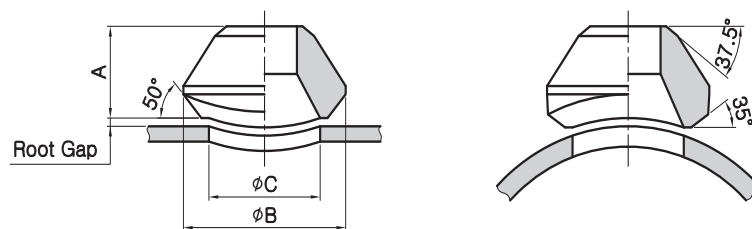

STD, X-S

Outlet Size	A		B		C		APP'Weight(kg)	
	STD	X-S	STD	X-S	STD	X-S	STD	X-S
½	19.1	19.1	34.9	34.9	23.8	23.8	0.08	0.09
¾	22.2	22.2	44.5	44.5	30.2	30.2	0.11	0.14
1	27.0	27.0	54.0	54.0	36.5	36.5	0.23	0.21
1¼	31.8	31.8	65.1	65.1	44.5	44.5	0.36	0.41
1½	33.3	33.3	73.0	73.0	50.8	50.8	0.45	0.50
2	38.1	38.1	88.9	88.9	65.1	65.1	0.80	0.80
2½	41.3	41.3	103.2	103.2	76.2	76.2	1.14	1.20
3	44.5	44.5	122.2	122.2	93.7	93.7	1.82	1.90
4	50.8	50.8	152.4	152.4	120.7	120.7	2.86	2.90
5	57.2	57.2	179.4	179.4	141.3	141.3	4.66	4.70
6	60.3	77.8	215.9	225.4	169.9	169.9	6.45	10.50
8	69.9	98.5	263.5	292.1	220.7	220.7	10.68	16.80
10	77.8	93.7	322.3	323.9	274.7	265.1	17.73	20.90
12	85.7	103.2	377.8	397.4	325.4	317.5	26.82	27.70
14	88.9	100.0	409.6	431.8	357.2	350.8	30.00	31.80
16	93.7	106.4	463.6	466.7	408.0	403.2	34.10	46.40
18	96.8	111.1	520.7	523.9	458.8	455.6	44.10	59.10
20	101.6	119.1	571.5	582.6	508.0	509.6	53.60	71.80
24	115.9	139.7	689.0	708.0	614.4	638.2	100.00	131.80

Sch 160, XX-S

Outlet Size	A		B		C		APP'Weight(kg)	
	Sch 160	XX-s	Sch 160	XX-s	Sch 160	XX-s	Sch 160	XX-s
½	28.6	28.6	34.9	34.9	14.3	14.3	0.11	-
¾	31.8	31.8	44.5	44.5	19.1	19.1	0.32	-
1	38.1	38.1	50.8	50.8	25.4	25.4	0.38	0.38
1¼	44.5	44.5	61.9	61.9	33.3	33.3	0.57	0.57
1½	50.8	50.8	69.9	69.9	38.1	38.1	0.80	0.80
2	55.6	55.6	81.0	81.0	42.9	42.9	1.00	1.00
2½	61.9	61.9	96.8	96.8	54.0	54.0	1.54	1.54
3	73.0	73.0	120.7	120.7	73.0	73.0	2.90	2.90
4	84.1	84.1	152.4	152.4	98.4	98.4	4.80	4.80
5	93.7	93.7	187.3	187.3	122.2	122.2	6.50	6.50
6	104.8	104.8	220.7	220.7	146.1	146.1	12.70	12.70
8	111.1	111.1	284.2	284.2	173.0	173.0	20.50	20.50
10	125.4	125.4	312.7	312.7	215.9	215.9	38.60	38.60

- Applicable run pipe sizes are from outlet size to 36inch

Socketolet
SCLT

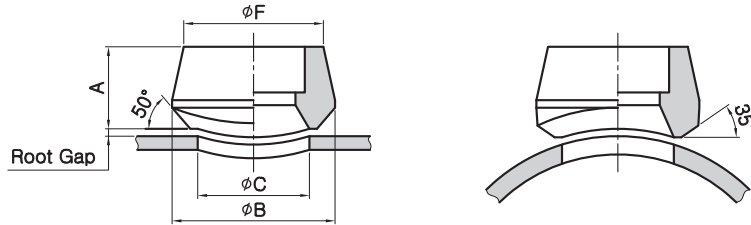

Outlet Size	A		B		C		F		APP'Weight(kg)	
	3000#	6000#	3000#	6000#	3000#	6000#	3000#	6000#	3000#	6000#
½	25.4	31.8	34.9	44.5	23.8	19.1	31.8	39.7	0.14	0.23
¾	27.0	36.5	44.5	50.8	30.2	25.4	36.5	46.6	0.15	0.36
1	33.3	39.7	54.0	61.9	36.5	33.3	46.0	57.2	0.27	0.59
1¼	33.3	41.3	65.1	69.9	44.5	38.1	55.6	65.1	0.39	0.73
1½	34.9	42.9	73.0	82.6	50.8	49.2	61.9	76.2	0.47	0.91
2	38.1	58.7	88.9	103.2	65.1	58.7	74.6	92.1	0.73	2.33
2½	46.0	-	103.2	-	76.2	-	87.3	-	1.25	-
3	50.8	-	122.2	-	93.7	-	104.8	-	1.73	-
4	57.2	-	152.4	-	120.7	-	130.2	-	3.30	-

Threadolet
STLT

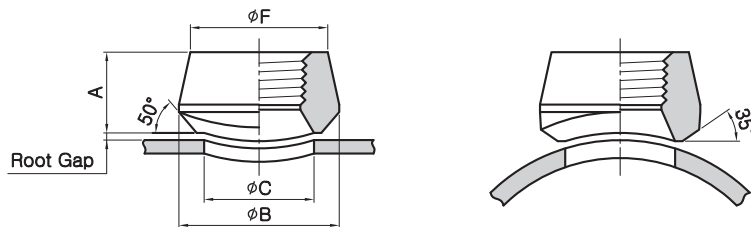

Outlet Size	A		B		C		F		APP'Weight(kg)	
	3000#	6000#	3000#	6000#	3000#	6000#	3000#	6000#	3000#	6000#
½	25.4	31.8	34.9	44.5	23.8	19.1	31.8	39.7	0.11	0.20
¾	27.0	36.5	44.5	50.8	30.2	25.4	36.5	46.6	0.16	0.34
1	33.3	39.7	54.0	61.9	36.5	33.3	46.0	57.2	0.28	0.56
1¼	33.3	41.3	65.1	69.9	44.5	38.1	55.6	65.1	0.41	0.71
1½	34.9	42.9	73.0	82.6	50.8	49.2	61.9	76.2	0.45	0.89
2	38.1	52.4	88.9	103.2	65.1	69.9	74.6	92.1	0.80	2.31
2½	46.0	-	103.2	-	76.2	-	87.3	-	1.36	-
3	50.8	-	122.2	-	93.7	-	104.8	-	1.98	-
4	57.2	-	152.4	-	120.7	-	130.2	-	3.23	-

- Applicable run pipe sizes are from outlet size to 36inch

Nipplet

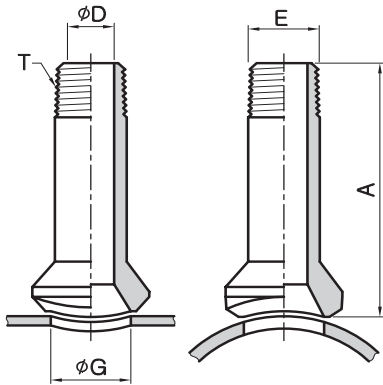

Run Pipe Size	Outlet Size T	A	G	D	E	Unit Weight (kg)
36-3/4	1/2	88.9	23.9	14.0	21.3	0.36
36-1	3/4	88.9	30.2	18.8	26.7	0.56
36-1	1	88.9	36.5	24.4	33.3	0.84
36-1	1 1/4	88.9	44.5	32.5	42.2	1.22
36-2	1 1/2	88.9	50.8	38.1	48.3	2.00
36-2	2	88.9	65.1	49.3	60.5	3.12

Swaged Nipple

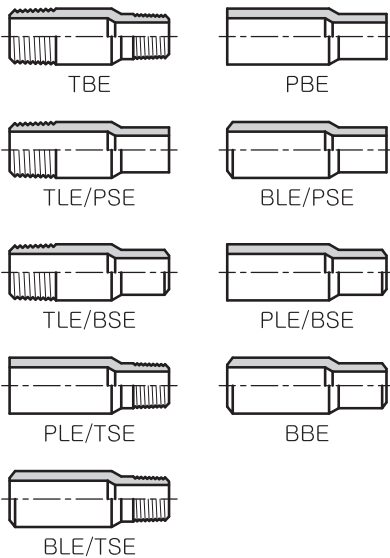

Large end Size	Small end Size	Length(mm)
1/2	3/8 - 1/8	70
3/4	1/2 - 1/8	76
1	1 - 1/8	89
1 1/4	1 1/4 - 1/8	102
1 1/2	1 1/2 - 1/8	114
2	1 1/2 - 1/8	165
2 1/2	2 - 1/8	178
3	2 1/2 - 1/8	203
3 1/2	3 - 1/8	203
4	3 1/2 - 1/8	229

TBE: Threaded both end
 PBE: Plain both end
 PLE/TSE: Plain large end-Threaded small end
 BLE/TSE: Beveled large end Threaded small end
 BLE/PSE: Beveled large end-Plain small end
 TLE/PSE: Threaded large end-Plain small-end

Swaged Nipples are made from Forged Steel or Pipe

1. Forged Socket Welding. Threaded Fitting Bore

in millimeters.

Nominal Pipe Size	ANSI B16.11				JIS B2316		
	Socket Welding(M)		Threaded(T)		Socket Welding(M)	Threaded(T)	
1/8"	10.90,	10.65	NPT	1/8	11.0	PT	1/8
1/4"	14.35,	14.10	NPT	1/4	14.3	PT	1/4
3/8"	17.80,	17.55	NPT	3/8	17.8	PT	3/8
1/2"	21.95,	21.70	NPT	1/2	22.2	PT	1/2
3/4"	27.30,	27.05	NPT	3/4	27.7	PT	3/4
1"	34.05,	33.80	NPT	1	34.5	PT	1
1 1/4"	42.80,	42.55	NPT	1 1/4	43.2	PT	1 1/4
1 1/2"	48.90,	48.65	NPT	1 1/2	49.1	PT	1 1/2
2"	61.35,	61.10	NPT	2	61.1	PT	2
2 1/2"	74.20,	73.80	NPT	2 1/2	77.1	PT	2 1/2
3"	90.15,	89.80	NPT	3	90.0	PT	3
4"	115.8,	115.45	NPT	4	115.4	PT	4

2. Tolerance

Forged Socket Welding, Threaded Fitting (ASME B16.11)

in millimeters.

Nominal Pipe Size	All Fittings				Elbow, Tee, Cross	Coupling	Half Coupling
	Socket Bore Dia	Bore Dia. of Fitting	Concentricity of Bore	Coincidence of Axis	Center to Bottom of Socket	Bottom to Bottom of Socket	Bottom of Socket to Opposite Face
1/8-1/4	+ 0.012 - 0.000	±0.03	Socket and Fitting bores within ±0.03	Maximum variation in alignment of socket and fitting bores for 1/8 in 12	±0.03	±0.06	±0.03
3/8-3/4	+ 0.012 - 0.000	±0.03			±0.06	±0.12	±0.06
1-2	+ 0.012 - 0.000	±0.03			±0.08	±0.16	±0.08
2 1/2-3	+ 0.012 - 0.000	±0.06			±0.10	±0.20	±0.10

3. KS B0222 & JIS B0203 Pipe Threads

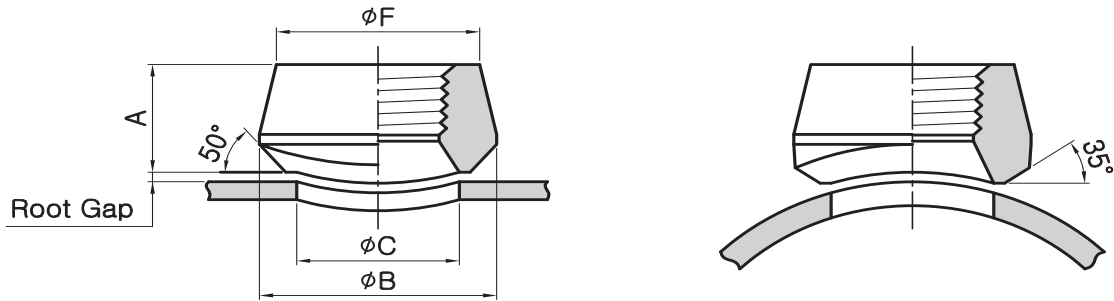

Nominal Size	Nominal Size	Screw Thread				Basic Diameter			Position of Basic Diameter			Tolerances on Basic Diameters of Internal Parallel Thread	Effective Thread Length (Min)				Nominal Pipe Size (For Reference)	
		Pitch	Height of Thread	Rounding	External Thread			External Thread	Internal Thread		Fitting Allowance		External Thread		Internal Thread			
					Major Diameter d	Pitch Diameter d2	Minor Diameter d1	From the End' of Pipe	The End of Pipe	Internal Thread			When there is an incomplete thread or More	When There is on Incomplete Thread				
															Basic Length	Tolerance Axially		
					Major Diameter	Pitch Diameter	Minor Diameter	Outside Diameter	Wall thickness									
n	p	h	r	D	D2	D1	a	±b	±C	±	f	l	l	t	Outside Diameter	Wall thickness		
PT	15(½)	14	1.8143	1.162	0.25	20.955	19.793	18.631	8.16	1.81	2.27	0.142	5.00	12.7	15.0	9.1	21.7	2.8
PT	20(¾)	14	1.8143	1.162	0.25	26.441	25.279	24.117	9.53	1.81	2.27	0.142	5.60	14.1	16.3	10.2	27.2	2.8
PT	25(1)	11	2.3091	1.479	0.32	33.249	31.770	30.291	10.39	2.31	2.89	0.180	6.40	16.2	19.0	11.5	34.0	3.2
PT	32(1¼)	11	2.3091	1.479	0.32	41.910	40.431	38.952	12.70	2.31	2.89	0.180	6.40	18.5	21.4	13.4	42.7	3.5
PT	40(1½)	11	2.3091	1.479	0.32	47.803	46.324	44.845	12.70	2.31	2.89	0.180	6.40	18.5	21.4	13.4	48.6	3.5
PT	50(2)	11	2.3091	1.479	0.32	59.614	58.135	56.656	15.88	2.31	2.89	0.180	7.50	22.8	25.7	16.9	60.5	3.8
PT	65(2½)	11	2.3091	1.479	0.32	75.184	73.705	72.226	17.46	3.64	3.46	0.217	9.22	26.7	30.2	18.6	76.3	4.2
PT	80(3)	11	2.3091	1.479	0.32	87.884	86.405	84.926	20.64	3.64	3.46	0.217	9.22	29.9	33.3	21.1	89.1	4.2
PT	90(3½)	11	2.3091	1.479	0.32	100.330	98.851	97.372	22.23	3.64	3.46	0.217	9.30	31.5	34.9	22.4	101.6	4.2
PT	100(4)	11	2.3091	1.479	0.32	113.030	111.551	110.072	25.40	3.64	3.46	0.217	10.40	35.9	39.3	25.9	114.3	4.5
PT	125(5)	11	2.3091	1.479	0.32	138.430	136.952	135.472	25.58	3.64	3.46	0.217	11.40	40.1	43.6	29.3	139.8	4.5
PT	150(6)	11	2.3091	1.479	0.32	163.830	162.351	160.872	28.58	3.64	3.46	0.217	11.50	40.1	43.6	29.3	165.2	5.0

4. ASME B2.1 Taper Pipe Threads. (Except Dryseal)

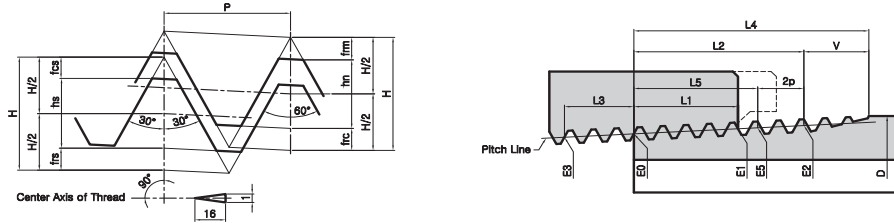

Thread Element	27 Threads Per inch p= 0.03704	18 Threads Per inch p= 0.05556	14 Threads Per inch p= 0.07143	11½ Threads Per inch p= 0.08696	8 Threads Per inch p= 0.12500
H=0.866p	0.0321	0.4810	0.0619	0.0753	0.1082
hs=hh=0.760p	0.0281	0.0422	0.0543	0.0661	0.0950
frs=frn=0.033p	0.0012	0.0088	0.0024	0.0029	0.0041
fcs=fcn=0.073p	0.0027	0.0041	0.0052	0.0063	0.0091

Nominal Pipe Size (NPT)	Outside Diameter of Pipe D	Threads Per inch n	Pitch of Thread P	Pitch Effective Thread, External Diameter at beginning of External Thread	Handtight Engagement			Effective Thread, External		
					Length L1		Dia E1	Length L2		Dia E2
					In.	Thds.		In.	Thds.	
1	2	3	4	5	6	7	8	9	10	11
1/8	0.405	27.0	0.03704	0.36351	0.1615	4.36	0.37360	0.2639	7.12	0.38000
1/4	0.540	18.0	0.05556	0.47739	0.2278	4.10	0.49163	0.4018	7.23	0.50250
3/8	0.675	18.0	0.05556	0.61201	0.2400	4.32	0.62701	0.4078	7.43	0.63750
1/2	0.840	14.0	0.07143	0.75843	0.3200	4.48	0.77843	0.5337	7.47	0.79179
3/4	1.050	14.0	0.07143	0.96768	0.3390	4.75	0.98887	0.5457	7.64	1.00179
1	1.315	11.5	0.08696	1.21363	0.4000	4.60	1.23863	0.6828	7.85	1.25630
1 1/4	1.660	11.5	0.08696	1.55713	0.4200	4.83	1.58338	0.7068	8.13	1.60130
1 1/2	1.900	11.5	0.08696	1.79609	0.4200	4.83	1.82234	0.7235	8.32	1.84130
2	2.375	11.5	0.08696	2.26902	0.4360	5.01	2.29627	0.7565	8.70	2.31630
2 1/2	2.875	8.0	0.12500	2.71953	0.6820	5.46	2.76216	1.1375	9.10	2.79062
3	3.500	8.0	0.12500	3.34062	0.7660	6.13	3.38850	1.2000	9.60	3.41562
3 1/2	4.000	8.0	0.12500	3.83750	0.8210	6.57	3.88881	1.2500	10.00	3.91562
4	4.500	8.0	0.12500	4.33438	0.8440	6.75	4.38712	1.3000	10.40	4.41562

Nominal Pipe Size (NPT)	Wrench Makeup Length for External Thread L2 L1		Wrench Makeup Length for External Thread			Vanish Thread V		Overall Length External Thread L4	Nominal, Complet External Threads ^s		Height of Thread h	Increase in Dia per Thread, 0.0625/n	Basic Minor Dia at Small End of Pipe, Ka
	In.	Thds.	Length L3		Dia E3	In.	Thds.		Length L5	Dia L5			
			In.	Thds.									
1	12	13	14	15	16	17	18	19	20	21	22	23	24
1/8	0.1024	2.76	0.1111	3	0.35656	0.1285	3.47	0.3924	0.1898	0.37537	0.02963	0.00231	0.3339
1/4	0.1740	3.13	0.1667	3	0.46697	0.1928	3.47	0.5946	0.2907	0.49556	0.04444	0.00347	0.4329
3/8	0.1678	3.02	0.1667	3	0.60160	0.1928	3.47	0.6006	0.2967	0.63056	0.04444	0.00347	0.5676
1/2	0.2137	2.99	0.2143	3	0.74504	0.2478	3.47	0.7815	0.3909	0.78286	0.05714	0.00446	0.7013
3/4	0.2067	2.89	0.2143	3	0.95429	0.2478	3.47	0.7935	0.4029	0.99286	0.05714	0.00446	0.9105
1	0.2828	3.25	0.2609	3	1.19733	0.3017	3.47	0.9845	0.5089	1.24543	0.06957	0.00543	1.1441
1 1/4	0.2868	3.30	0.2609	3	1.54083	0.3017	3.47	1.0085	0.5329	1.59043	0.06957	0.00543	1.4876
1 1/2	0.3035	3.49	0.2609	3	1.77978	0.3017	3.47	1.0252	0.5496	1.83043	0.06957	0.00543	1.7265
2	0.3205	3.69	0.2609	3	2.25272	0.3017	3.47	1.0582	0.5826	2.30543	0.06957	0.00543	2.1995
2 1/2	0.4555	3.64	0.2500 ⁷	2	2.70391	0.4337	3.47	1.5712	0.8875	2.77500	0.10000	0.00781	2.6195
3	0.4340	3.47	0.2500 ⁷	2	3.32500	0.4337	3.47	1.6337	0.9500	3.40000	0.10000	0.00781	3.2406
3 1/2	0.4290	3.43	0.2500	2	3.82188	0.4337	3.47	1.6837	1.0000	3.90000	0.10000	0.00781	3.7375
4	0.4560	3.65	0.2500	2	4.31875	0.4337	3.47	1.7337	1.0500	4.40000	0.10000	0.00781	4.2344

5. Wall Thickness Schedules.

Nominal Pipe Size		Outside Diameter		Nominal Wall Thickness								
A	B	JIS	ANSI	Sch5S	SchS10S	Sch20S	GS	Sch10	LG(7.9)	Sch20	Sch30	STD
8	¼	13.8	13.7	1.2	1.65	2.0	2.3	-	-	-	-	(2.2)
10	⅜	17.3	17.1	1.2	1.65	2.0	2.3	-	-	-	-	(2.3)
15	½	21.7	21.3	1.65	2.1	2.5	2.8	-	-	-	-	(2.8)
20	¾	27.2	26.7	1.65	2.1	2.5	2.8	-	-	-	-	(2.9)
25	1	34.0	33.4	1.65	2.8	3.0	3.2	-	-	-	-	(3.4)
32	1-¼	42.7	42.2	1.65	2.8	3.0	3.5	-	-	-	-	(3.6)
40	1-½	48.6	48.3	1.65	2.8	3.0	3.5	-	-	-	-	(3.7)
50	2	60.5	60.3	1.65	2.8	3.5	3.8	-	-	-	-	(3.9)
65	2-½	76.3	73.0	2.1	3.0	3.5	4.2	-	-	-	-	(5.2)
80	3	89.1	88.9	2.1	3.0	4.0	4.2	-	-	-	-	(5.5)
90	3-½	101.6	101.6	2.1	3.0	4.0	4.2	-	-	-	-	(5.7)
100	4	114.3	114.3	2.1	3.0	4.0	4.5	-	-	-	-	(6.0)
125	5	139.8	141.3	2.8	3.4	5.0	4.5	-	-	-	-	(6.6)
150	6	165.2	168.3	2.8	3.4	5.0	5.0	-	5.0	-	-	(7.1)
175	7	190.7	-	-	-	-	5.3	-	-	-	-	-
200	8	216.3	219.1	2.8	3.8	6.5	5.8	-	5.8	6.4	7.0	(8.2)
225	9	241.8	-	-	-	-	6.2	-	-	-	-	-
250	10	267.4	273.1	3.4	4.2	6.5	6.6	-	6.6	6.4	7.8	(9.3)
300	12	318.5	323.9	4.0	4.6	6.5	6.9	-	6.9	6.4	8.4	9.5
350	14	355.6	355.6	4.0	4.8	7.9	7.9	6.4	7.9	7.9	9.5	9.5
400	16	406.4	406.4	4.2	4.8	7.9	7.9	6.4	7.9	7.9	9.5	9.5
450	18	457.2	457.2	4.2	4.8	7.9	7.9	6.4	7.9	7.9	11.1	9.5
500	20	508.0	508.0	4.8	5.5	7.9	7.9	6.4	7.9	9.5	12.7	9.5
550	22	558.8	558.8	4.8	5.5	-	-	6.4	7.9	9.5	12.7	9.5
600	24	609.6	609.6	5.5	6.4	-	-	6.4	7.9	9.5	14.3	9.5
650	26	660.4	660.4	-	-	-	-	7.9	7.9	12.7	-	9.5
700	28	711.2	711.2	-	-	-	-	7.9	7.9	12.7	15.9	9.5
750	30	762.0	762.0	6.4	7.9	-	-	7.9	7.9	12.7	15.9	9.5
800	32	812.8	812.8	-	-	-	-	7.9	7.9	12.7	15.9	9.5
850	34	863.6	863.6	-	-	-	-	7.9	7.9	12.7	15.9	9.5
900	36	914.4	914.4	-	-	-	-	7.9	7.9	12.7	15.9	9.5
950	38	965.2	965.2	-	-	-	-	-	7.9	-	-	9.5
1000	40	1016.0	1016.0	-	-	-	-	-	7.9	-	-	9.5
1050	42	1066.8	1066.8	-	-	-	-	-	7.9	-	-	9.5
1100	44	1117.6	1117.6	-	-	-	-	-	7.9	-	-	9.5
1150	46	1168.4	1168.4	-	-	-	-	-	7.9	-	-	9.5
1200	48	1219.2	1219.2	-	-	-	-	-	7.9	-	-	9.5
1250	50	1270.0	1270.0	-	-	-	-	-	*7.9	-	-	*9.5
1300	52	1320.8	1320.8	-	-	-	-	-	*7.9	-	-	*9.5
1350	54	1371.6	1371.6	-	-	-	-	-	*7.9	-	-	*9.5
1400	56	1422.4	1422.4	-	-	-	-	-	*7.9	-	-	*9.5
1450	58	1473.2	1473.2	-	-	-	-	-	*7.9	-	-	*9.5
1500	60	1524.0	1524.0	-	-	-	-	-	*7.9	-	-	*9.5

JIS G3448 ANSI B36.10M
 JIS G3454 ANSI B36.19M
 JIS G3455
 JIS G3459

(in mm)

Nominal Wall Thickness									Outside Diameter		Nominal Pipe Size	
Sch40	Sch60	XS	Sch80	Sch100	Sch120	Sch140	Sch160	XXS	JIS	ANSI	A	B
2.2	2.4	(3.0)	3.0	-	-	-	-	-	13.8	13.7	8	¼
2.3	2.8	(3.2)	3.2	-	-	-	-	-	17.3	17.1	10	⅜
2.8	3.2	(3.7)	3.7	-	-	-	4.7	7.5	21.7	21.3	15	½
2.9	3.4	(3.9)	3.9	-	-	-	5.5	7.8	27.2	26.7	20	¾
3.4	3.9	(4.5)	4.5	-	-	-	6.4	9.1	34.0	33.5	25	1
3.6	4.5	(4.9)	4.9	-	-	-	6.4	9.7	42.7	42.2	32	1-¼
3.7	4.5	(5.1)	5.1	-	-	-	7.1	10.2	48.6	48.3	40	1-½
3.9	4.9	(5.5)	5.5	-	-	-	8.7	11.1	60.5	60.3	50	2
5.2	6.0	(7.0)	7.0	-	-	-	9.5	14.0	76.3	73.0	65	2-½
5.5	6.6	(7.6)	7.6	-	-	-	11.1	15.2	89.1	88.9	80	3
5.7	7.0	(8.1)	8.1	-	-	-	12.7	-	101.6	101.6	90	3-½
6.0	7.1	(8.6)	8.6	-	11.1	-	13.5	17.1	114.3	114.3	100	4
6.6	8.1	(9.5)	9.5	-	12.7	-	15.9	19.0	139.8	141.3	125	5
7.1	9.3	(11.0)	11.0	-	14.3	-	18.2	21.9	165.2	168.3	150	6
-	-	-	-	-	-	-	-	-	190.7	-	175	7
8.2	10.3	(12.7)	12.7	15.1	18.2	20.6	23.0	22.2	216.3	219.1	200	8
-	-	-	-	-	-	-	-	-	241.8	-	225	9
9.3	12.7	12.7	15.1	18.3	21.4	25.4	28.6	25.4	267.4	273.1	250	10
10.3	14.3	12.7	17.4	21.4	25.4	28.6	33.3	25.4	318.5	323.9	300	12
11.1	15.1	12.7	19.0	23.8	27.8	31.8	35.7	-	355.6	355.6	350	14
12.7	16.7	12.7	21.4	26.2	30.9	36.5	40.5	-	406.4	406.4	400	16
14.3	19.0	12.7	23.8	29.4	34.9	39.7	45.2	-	457.2	457.2	450	18
15.1	20.6	12.7	26.2	32.5	38.1	44.4	50.0	-	508.0	508.0	500	20
-	22.2	12.7	28.6	34.9	41.3	47.6	54.0	-	558.8	558.8	550	22
17.5	24.6	12.7	31.0	38.9	46.0	52.4	59.5	-	609.6	609.6	600	24
-	-	12.7	-	-	-	-	-	-	660.4	660.4	650	26
-	-	12.7	-	-	-	-	-	-	711.2	711.2	700	28
-	-	12.7	-	-	-	-	-	-	762.0	762.0	750	30
17.5	-	12.7	-	-	-	-	-	-	812.8	812.8	800	32
17.5	-	12.7	-	-	-	-	-	-	863.6	863.6	850	34
19.1	-	12.7	-	-	-	-	-	-	914.4	914.4	900	36
-	-	12.7	-	-	-	-	-	-	965.2	965.2	950	38
-	-	12.7	-	-	-	-	-	-	1016.0	1016.0	1000	40
-	-	12.7	-	-	-	-	-	-	1066.8	1066.8	1050	42
-	-	12.7	-	-	-	-	-	-	1117.6	1117.6	1100	44
-	-	12.7	-	-	-	-	-	-	1168.4	1168.4	1150	46
-	-	12.7	-	-	-	-	-	-	1219.2	1219.2	1200	48
-	-	12.7	-	-	-	-	-	-	1270.0	1270.0	1250	50
-	-	12.7	-	-	-	-	-	-	1320.8	1320.8	1300	52
-	-	12.7	-	-	-	-	-	-	1371.6	1371.6	1350	54
-	-	12.7	-	-	-	-	-	-	1422.4	1422.4	1400	56
-	-	12.7	-	-	-	-	-	-	1473.2	1473.2	1450	58
-	-	12.7	-	-	-	-	-	-	1524.0	1524.0	1500	60

6. Material Specifications

ASTM	Grade	Classification		C %	Mn %	P Max. %	S Max. %	Si %	Ni %	Cr %	Mo %	T.S. Min. psi (kg/mm ²)	Y.S. Min. psi (kg/mm ²)	EL Min. %	RED Min. %	HB
A-105*		Carbon Steel		Max 0.35	0.60~1.05	0.040	0.050	MAX 0.35	MAX 0.40	MAX 0.30	MAX 0.12	70,000 (49.2)	36,000 (25.3)	22	30	MAX 187
A-181*	60	Carbon Steel		Max 0.35	MAX 0.90	0.050	0.050	MAX (0.35)				60,000 (42.2)	30,000 (21.1)	22	35	
A-181	70	Carbon Steel		Max 0.35	MAX 0.90	0.050	0.050	MAX (0.35)				70,000 (49.2)	36,000 (25.3)	18	24	
A-182	F1	½	Mo	Max 0.35	0.60~0.90	0.045	0.045	0.15~0.35			0.44~0.65	70,000 (49.2)	40,000 (28.1)	20	30	143~192
A-182	F5	5Cr-½	Mo	Max 0.15	0.30~0.60	0.030	0.030	MAX 0.50	MAX 0.50	4.00~6.00	0.44~0.65	70,000 (49.2)	40,000 (28.1)	20	35	143~217
A-182	F5a	5Cr-½	Mo	Max 0.25	MAX 0.60	0.040	0.030	MAX 0.50	MAX 0.50	4.00~6.00	0.44~0.65	90,000 (63.3)	65,000 (45.7)	22	50	187~248
A-182	F11-1	1½Cr-½	Mo	0.05~0.15	0.30~0.60	0.030	0.030	0.50~1.00		1.00~1.50	0.44~0.65	60,000 (42.2)	30,000 (21.1)	20	45	121~174
A-182	F11-2	1½Cr-½	Mo	0.10~0.20	0.30~0.80	0.040	0.040	0.50~1.00		1.00~1.50	0.44~0.65	70,000 (49.2)	40,000 (28.1)	20	30	143~207
A-182	F11-3	1Cr-½	Mo	0.10~0.20	0.30~0.80	0.040	0.040	0.50~1.00		1.00~1.50	0.44~0.65	75,000 (52.7)	45,000 (31.6)	20	30	156~207
A-182	F12-1	1Cr-½	Mo	0.05~0.15	0.30~0.60	0.045	0.045	MAX 0.50		0.80~1.25	0.44~0.65	60,000 (42.2)	30,000 (21.1)	20	45	121~174
A-182	F12-2	1½Cr-½	Mo	0.10~0.20	0.30~0.80	0.040	0.040	0.10~0.60		0.80~1.25	0.44~0.65	70,000 (49.2)	40,000 (28.1)	20	30	143~174
A-182	F11	1Cr-½	Mo	0.10~0.20	0.30~0.60	0.040	0.040	0.50~1.00		1.00~1.50	0.44~0.65	70,000 (49.2)	40,000 (28.1)	20	30	143~207
A-182	F12	1Cr-½	Mo	0.10~0.20	0.30~0.80	0.040	0.040	0.10~0.60		0.80~1.25	0.44~0.65	70,000 (49.2)	40,000 (28.1)	20	30	143~207
A-182	F22	2½Cr-1	Mo	MAX 0.15	0.30~0.60	0.040	0.040	MAX 0.50		2.00~2.50	0.87~1.13	75,000 (52.7)	45,000 (31.6)	20	30	156~207
A-182	F304	18Cr-8	Ni	MAX 0.08	MAX 2.00	0.040	0.030	MAX 1.00	8.00~11.00	18.00~20.00		75,000 (52.7)	30,000 (21.1)	30	50	
A-182	F304L	18Cr-8 Low	Ni	MAX 0.035	MAX 2.00	0.040	0.030	MAX 1.00	8.00~13.00	18.00~20.00		75,000 (49.2)	25,000 (17.6)	30	50	
A-182	F316	18Cr-8 MO	Ni	MAX 0.08	MAX 2.00	0.040	0.030	MAX 1.00	10.00~14.00	16.00~18.00	2.00~3.00	75,000 (52.7)	30,000 (21.7)	30	50	
A-182	F316L	18Cr-8 MO-LOW	Ni	MAX 0.035	MAX 2.00	0.040	0.030	MAX 1.00	10.00~15.00	16.00~18.00	2.00~3.00	65,000 (45.7)	25,000 (17.6)	30	50	
A-182	F321	18Cr-8 Ti	Ni	MAX 0.08	MAX 2.00	0.030	0.030	MAX 1.00	9.00~12.00	Min 17.00		75,000 (52.7)	30,000 (21.1)	30	50	
A-182	F347	18Cr-8 Cb	Ni	MAX 0.08	MAX 2.00	0.030	0.030	MAX 1.00	9.00~13.00	17.00~20.00		75,000 (52.7)	30,000 (21.1)	30	50	
A-350*	LF1	Carbon Steel		MAX 0.30	0.75~1.05	0.035	0.040	0.15~0.30	MAX 0.40	MAX 0.30	MAX 0.12	60,000~85,000 (42.2~59.7)	30,000 (21.1)	25	38	
A-350*	LF2	Carbon Steel		MAX 0.30	MAX 1.35	0.035	0.040	0.15~0.30	MAX 0.40	MAX 0.30	MAX 0.12	70,000~95,000 (49.2~66.8)	36,000 (25.3)	22	30	
A-350*	LF3	3½	Ni	MAX 0.20	MAX 1.35	0.035	0.040	0.20~0.35	3.25~3.75	MAX 0.30	MAX 0.12	70,000~95,000 (49.2~66.8)	37,500 (26.4)	22	35	

*OTHER ELEMENTS : copper (0.40% MAX.), Vanadium, (0.03% MAX.), Columbium (0.02% MAX.)

*The sum of Cu, Ni, Cr and Mo Shall not be exceed 1.00%

*The sum of Cr and Mo shall not be exceed 0.32%

S-LOK®